

C3 Series



rinstrum
SMART WEIGHING SOLUTIONS



C350/C357

C350/ C357 full housing indicators

- 50.8mm (2in) LCD display with backlight
- RGB backlight to make check weighing easy
- 9 segment display for improved readability
- Fully Sealed
 - C350 Resin alloy full housing IP66, IP68 and NEMA 4
 - C357 Stainless steel full housing IP66, IP68, IP69K and NEMA 4X
- Wide DC operation (5-24V) ideal for onboard vehicle and industrial applications



Flush polyester overlay with mechanical keys

- No membrane keys to wear out
- Easy to keep clean
- Durable chemical resistance
- High UV Resistance

Lithium ion battery option

The re-chargeable long run time Li-ion battery is available as factory fit to AC units or as an accessory. The Li-ion provides a dramatic improvement in performance compared to older battery technology.

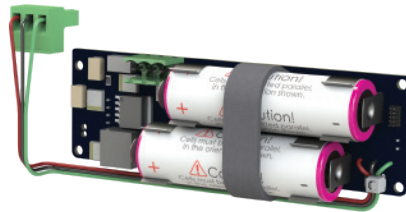

- Typical battery life - 50 hours
- Battery life can be extended even further depending on the application using backlight dimming and auto off features
- Simplified charging while indicator is in use
- Battery display showing real-time battery charge status and progress

RGB LCD display (Selectable up to 9 colours)

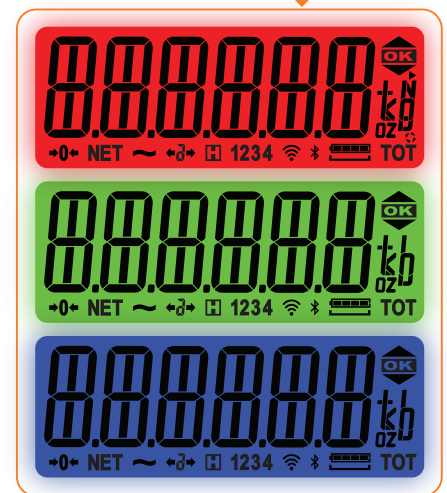

Firmware applications

- Custom printing
- Accumulation
- Counting
- Checkweighing
- Manual hold, peak hold, medical and livestock filtering
- Mimic/ remote display
- Advanced setpointing including latching outputs

viewC3 for fast, simple indicator setup via a PC

viewC3 is PC software that displays the complete menu structure of the indicator with convenient drop down menus for setting selection. Use viewC3 to:

- Enter custom print strings using the PC.
- Setup the indicator and save the configuration and calibration for maintenance purposes or load the RIS file onto multiple indicators.
- Create a real time graph from the log that is ideal for diagnostics.

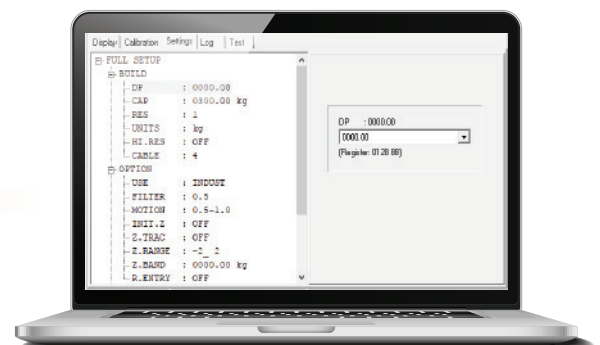

rinLINK for establishing a temporary connection to a PC

The rinLINK provides an isolated optical serial connection directly on the front of the indicator to be used for downloading new firmware or connecting to the PC running the Viewer for indicator configuration. It is magnetically coupled for easy access saving time and effort.



C350 / C357 rear

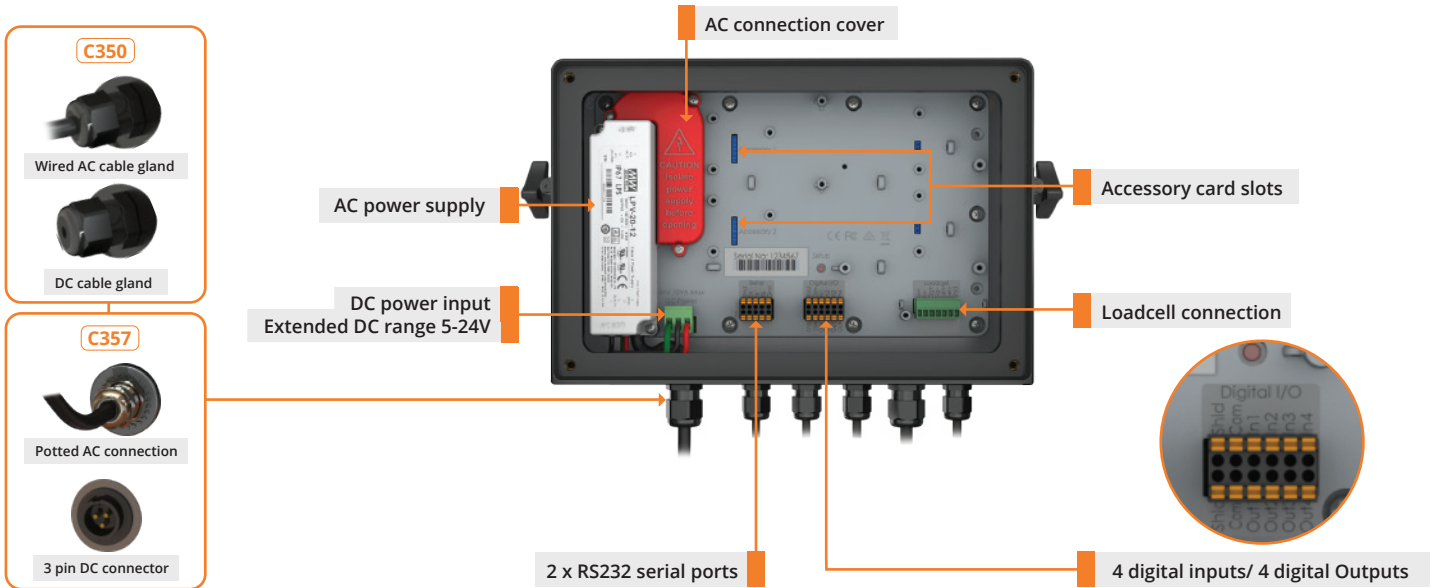

Built-in features (enabled according to firmware)

- Two RS232 bidirectional serial ports independently configurable for network, printing or remote display functions
- Four digital inputs and four high-side digital outputs that are electrically isolated. Outputs are capable of driving low voltage DC actuators directly
- Non-volatile memory storage for all operator parameters (eg: zero, tare, pieceweight etc.)
- Realtime clock calendar
- Integrated alibi memory (DSD)
- RGB backlight for setpoint and checkweigh applications
- Two accessory card slots for increased functionality

Accessory cards

Communications cards

In addition to the two built in RS232 ports, a third serial port can be added to extend the connectivity. This serial port can be 20mA current loop, RS232, or RS485.

Analogue output card

The analogue output card can be used to extend the capability of the C3 for industrial control environments.

- Analogue output 4-20mA, 0-10V, isolated 16 bit output

Analogue output card



rinPRINT - Rinstrum's custom print wizard

With rinPRINT you set the print width, then drag and drop the print tokens into the editor pane to create a custom print configuration. Add your own text descriptions and format the layout and spacing by moving the field around in the editor pane. The data displayed is the live data from the indicator. rinPRINT makes creating custom print dockets easy.

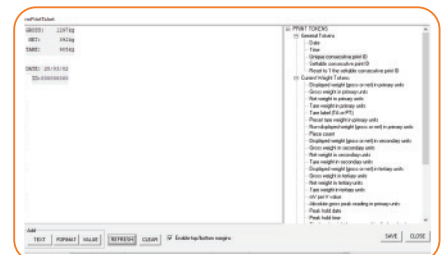

Advanced setpoints

The C3 instruments support up to 8 setpoints with setpoints 1 and 2 linked to the onboard digital outputs. Setpoint status can be used to drive the onboard outputs directly, sound the buzzer, change display backlight colour.

Setpoint outputs can be latched and reset from remote inputs or external control.

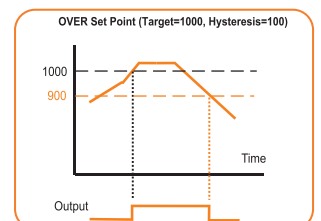

C350 Resin Alloy Full Housing

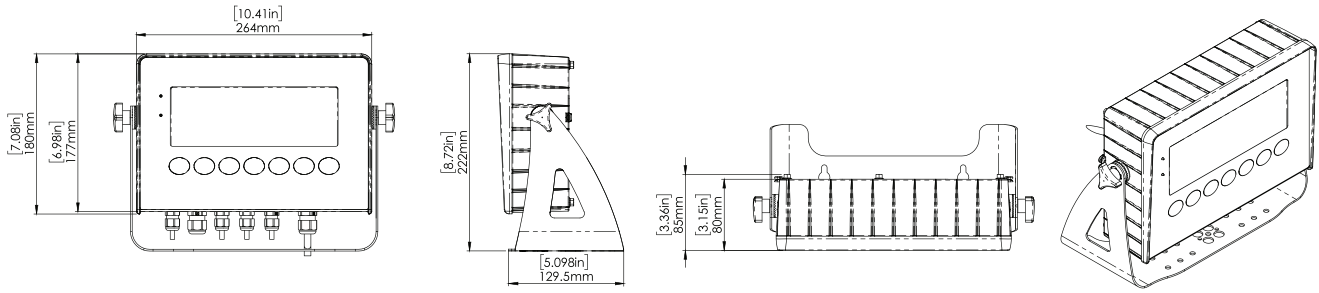

C357 Stainless Steel Housing

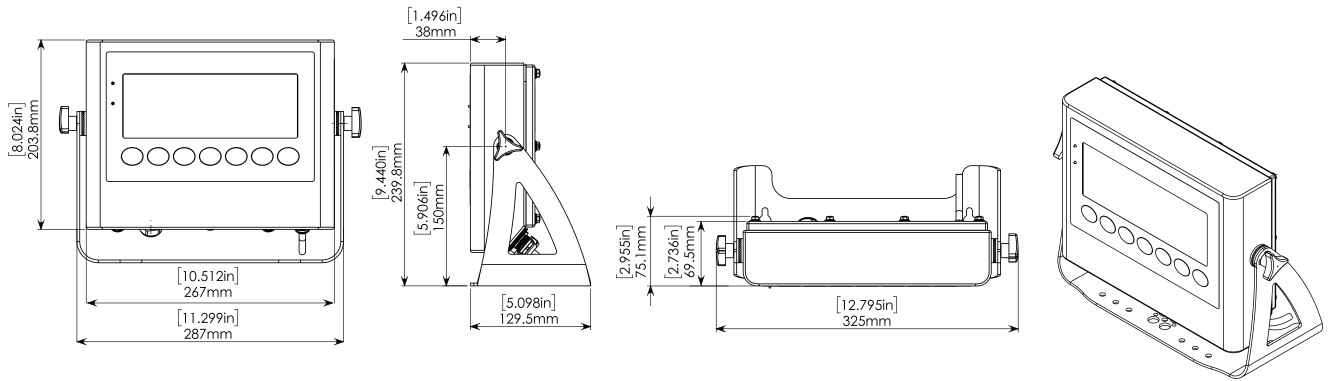

Check out the whole C3 Series



C320
Compact panel
mount/ resin alloy
housing



C327
Compact stainless steel
housing



C350
Super-sized display
resin alloy housing



C357
Super-sized display
stainless steel housing

Local Dealer



Contact Us