

SMART WEIGHING SOLUTIONS



rinstrum
SMART WEIGHING SOLUTIONS

**C3 Series
Digital Indicators
Quick Start Manual**

C300-611 US Rev 1.1.0

Copyright

All Rights Reserved. No part of this document may be copied, reproduced, republished, uploaded, posted, transmitted, distributed, stored in or introduced into a retrieval system in any form, or by any means (electronic, mechanical, photocopying, recording or otherwise) whatsoever without prior written permission of Rinstrum Pty Ltd.

Disclaimer

Rinstrum Pty Ltd reserves the right to make changes to the products contained in this manual in order to improve design, performance or reliability. The information in this manual is believed to be accurate in all respects at the time of publication, but is subject to change without notice. Rinstrum Pty Ltd assumes no responsibility for any errors or omissions and disclaims responsibility for any consequences resulting from the use of the information provided herein.

Contents

1	Introduction	1
2	Specifications	2
3	Installation	3
3.1	Loadcell Connection	3
3.2	Other Connections (Serial, Digital Inputs and Outputs)	5
3.3	Optical Communications	9
3.4	Accessory Card connection	9
4	Setup Menus	11
4.1	Accessing Setup Menus	11
4.2	Language	11
4.3	General Options	11
4.4	Scale	14
4.5	Serial	22
4.6	Set Points (K304 - 8 Basic, K306 - 8 Advanced)	24
4.7	App	26
4.8	Test	31
4.9	Analog Output (K306)	32
4.10	DSD (K304, K306)	33
4.11	End	33
5	Quick Calibration	34
6	Appendix - Error Messages	35
6.1	Weighing Errors	35
6.2	Setup Errors	35
6.3	Diagonostic Errors	36
6.4	Calibration Errors	37

1. INTRODUCTION

This manual contains information on the installation, calibration and setup of the instrument.

Trade Modes

The instrument may be operated in Industrial or Trade modes. These modes restrict certain aspects of the operation of the instrument to ensure compliance with trade certified standards.

Element	Industrial	OIML	NTEP
Underload	-105% of Fullscale	-20 divisions	-1% or -2% of Fullscale depending on zero range setting
Overload	105% of Fullscale	Fullscale + 9 divisions	105% of Fullscale
Tare	No restrictions	Tare values must be > 0	Tare values must be > 0
Test Modes	Unlimited time allowed	Limited to five seconds	Limited to five seconds

Manuals

- For more information on this instrument refer the Reference Manual: C300-600.
- For Connector Pinouts refer R000-220.



Figure 1: C3 Series Indicators

2. SPECIFICATIONS

General	
Trade approval	NTEP 23-090 / NMI S869 / OIML R76-1 (2006)
Resolution	Up to 100,000 divisions, minimum of 0.1uV/division Trade: Up to 10,000 divisions, minimum of 0.33uV/division
Zero cancellation	± 2.0mV/V
Span adjustment	0.1mV/V to 5.0mV/V full scale
Excitation	5V for up to 8 x 350-ohm load cells (4-wire or 6-wire plus shield) Max total load cell resistance: 3,500Ω
A/D type	24bit Sigma Delta with 8,388,608 internal counts, 50 updates/second
Operating environment	Temperature: -10° to +50°C ambient (14° to 122° F), Humidity: <90% non-condensing
Setup and calibration	Fully digital with visual prompting in plain messages
Digital filter	IIR low pass filter
Zero range	Selectable from ± 2% to ± 100% Full Scale
Standard power input	5 to 24VDC (2.5 VA max) ON/OFF key with memory feature
Optical data communications	rinLINK - magnetically coupled infra-red communications Conversion cables available for USB
Keys US region	Power/ Zero/ Tare/ Select/ Units Switching (lb/ kg/ oz/ g/ t/ TN/ lb:oz/custom) plus two assignable function keys
Keys ROW region	Power/ Zero/ Tare/ Select plus three assignable function keys
Accessory Cards	
Communications cards	RS485, RS232, Current loop
Expansion cards (K306 Only)	0-10V, 4-20mA, isolated 16 bit analog output

	C320-A	C320-G	C320-H	C327	C350	C357
Display	RGB Backlit LCD with six 20mm (0.8") high digits with units and annunciators, 9 segment				RGB Backlit LCD with six 50.8mm (2") high digits with units and annunciators, 9 segment	
Case materials	Resin Alloy			Stainless Steel	Resin Alloy	Stainless Steel
IP Rating	IP66 with A11096 stiffening plate	IP20	IP66	IP66, IP68, IP69K, NEMA 4X	IP66, IP68, NEMA4	IP66, IP68, IP69K, NEMA 4X
Packing Weights	0.25kg/ 9oz	0.42kg/ 14.8oz		3.5kg/ 7.7lbs	3.8kg/ 8.4lbs	5.5kg/ 12.1lbs

	C320-A	C320-G	C320-H
Plug Pack (AC 110-240 VAC)	Option	Included	Included
DC 5-24 VDC	Rear connector	Uses Barrel connector	Factory fit via cable gland
M6001 Battery boot (Using 4*AA batteries)	Option	Factory Fitted	-
M6003 (Boot)	Option	-	Factory fitted

	C327	C350	C357
AC 110-240 VAC	Potted AC Line Cord	Cable gland with AC line cord	Potted AC Line Cord
DC 5-24 VDC	3 pin LTW connector	Cable gland (without cord)	3 pin LTW connector
M6103 (Battery accessory)	Optional two Li-ion 18650 3500mAh		
AC + Battery (-F variant in catalogue)	As per AC specification with factory fitted battery (two Li-ion 18650 3500mAh)		

Specifications may change at any time without notice.

3. INSTALLATION

The following steps are required to set up the indicator.

- Inspect indicator to ensure good condition.
- Use connection diagrams to wire up load cell, power and auxiliary cables as required.
- Insert any accessory modules that are being used.
- Use the drill hole template provided for hole locations.
- Connect Power to indicator and press <power> key to turn the instrument On.
- Refer to the Configuration for information on configuring the instrument.
- To turn instrument OFF press and hold key for three seconds (until display blanks).

3.1 Loadcell Connection

The C3 series can drive any number of full bridge strain gauge loadcells up to the equivalent of 8 x 350 ohm cells.

The span range of the loadcell outputs (the change of signal from the loadcells between zero load and full gross load) must be within the range of 0.1 to 5.0 mV/V. Very low output scale bases can be used with the C3 series, but may induce some instability in the weight readings when used with higher resolutions. Generally speaking, the higher the output, or the lower the number of divisions, the greater the display stability and accuracy.

When shunting loadcells, use only good quality metal film resistors with high temperature stability ratings. Typical values for zero adjustment would fall within the range of 500k ohms (small effect) to 50k ohms (larger effect).

The C3 series has a mV/V meter test mode which can be used to check scale base signal output levels. Refer to mV/V test mode [31](#).

3.1.1 6-Wire Connection

The loadcell socket is wired for six wire systems as follows:

Screw Terminal Pin	Function
1	Positive excitation
2	Negative excitation
3	Positive signal
4	Negative signal
5	Positive sense
6	Negative sense
7	Shield

Loadcell wires are connected as shown in below diagram.

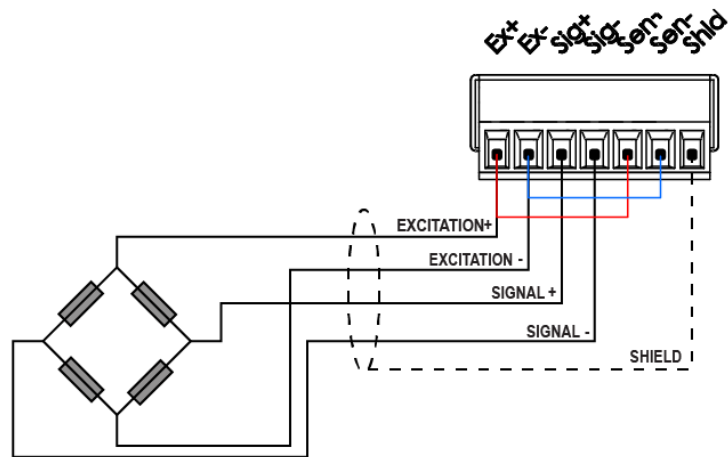

Figure 2: 6-Wire Connection

3.1.2 4-Wire Connection

The minimum connectivity requirements for loadcell connection are the connection of four wires (i.e. \pm Excitation and \pm Signal). When a four wire loadcell system is connected, it is necessary to ensure that the excitation voltages are fed into the sense inputs using jumper wires as shown in below diagram.

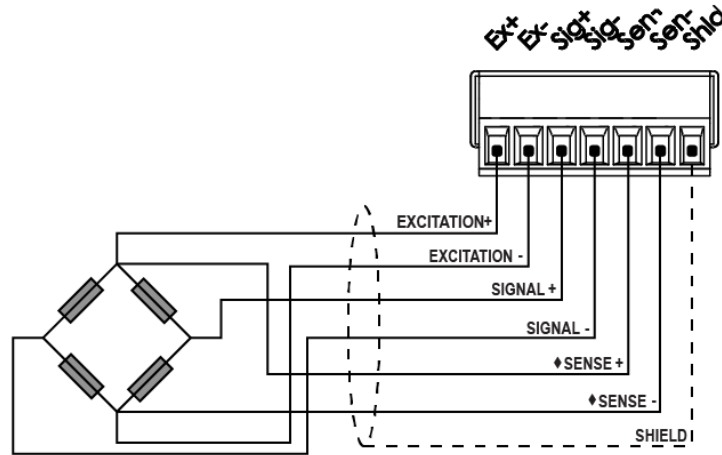

Figure 3: 4-Wire Connection

Any addition to the load cell manufacturer's cable length using 4-wire connection is only recommended for short cable runs. Where long additions to cable lengths are needed, a 6-wire extension is required.

Warning! Sense lines must be connected or 4/6 wire jumpers fitted as shown in dashed lines in above figure. Failure to do this will result in the C3 series displaying an error message (E0200C).

3.2 Other Connections (Serial, Digital Inputs and Outputs)

The C3 supports the following connections:

- 2 x serial ports (2 bi-directional RS232) (K304, K306)
- 2 x isolated digital inputs in C32x and 4 x isolated digital inputs in C35x (K304, K306)
- 2 x isolated high side switched digital outputs in C32x and 4 x isolated high side switched digital outputs in C35x (K304, K306)
- 1 x regulated 5 V output for driving small loads (below 0.5 A)

3.2.1 Serial Port 1 & 2 Connections

C3 series indicators have two RS232 (bi-directional) ports. The RS232 drivers are generally used for connecting external computers or PLCs. The connections are shown below.

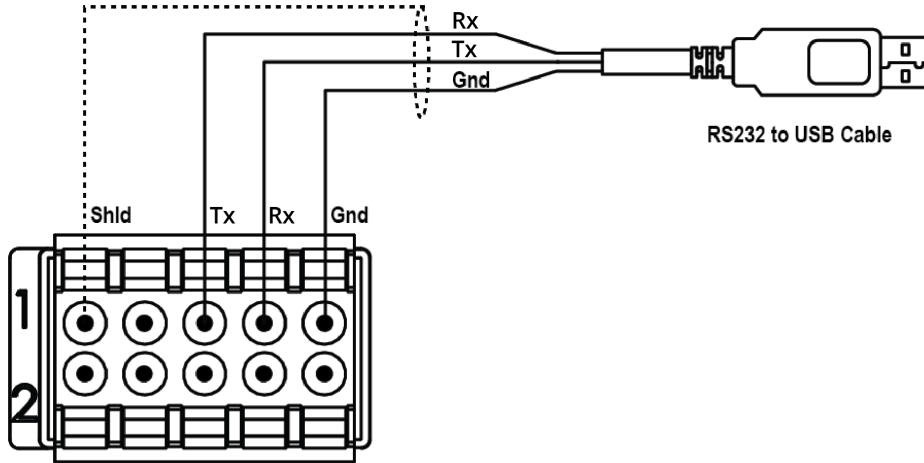

Figure 4: RS232 to USB Connection

Pin Number	Function	Direction	Connect to external device
1	Shld	Shield	Connect to cable shield
2 *	5V	5V output	Power for printer or converter (300mA max)
3	TX	RS232 transmit	Receive (Rx pin of the converter)
4	RX	RS232 receive	Transmit (Tx pin of the converter)
5	Gnd	RS232 ground	Ground

Warning! Pin number 2: 5 V Power output is not an input. Do not attempt to power the indicator by connecting 5V DC source to this pin.

Ring Networks

C320, C327, C350 and C357 can be configured in a Ring Network to connect multiple indicators to an external computer or PLC. The connections are shown below.

When operating in a Ring Network, the Instruments:

- must have same serial port options, i.e., baud, parity, data bits, stop bits.
- recommended that all indicators use the same power supply.

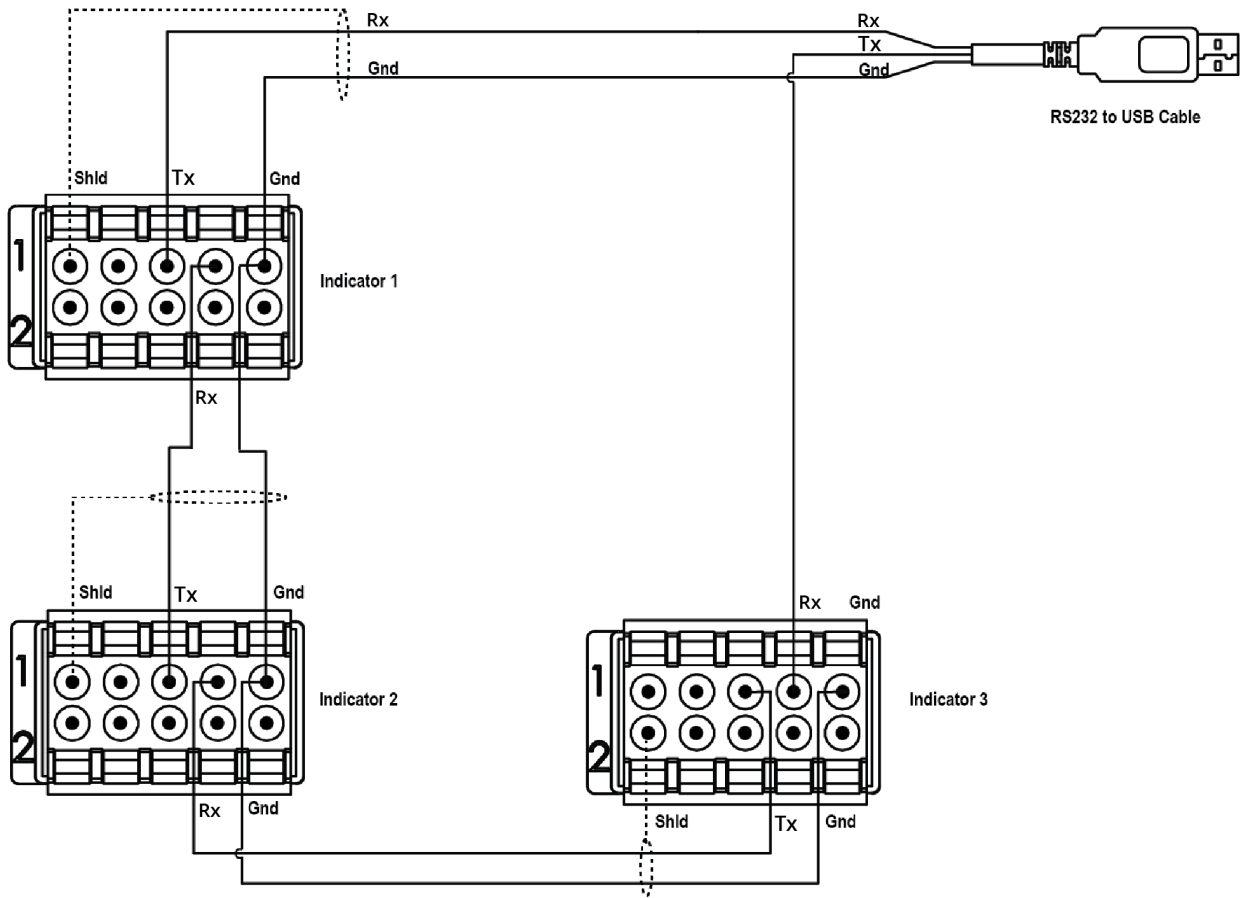

Figure 5: Ring Network Connections

Remote Display

The remote display documentation should be referred for connection details. Connect Tx to Rx, Rx to Tx and GND on the remote display as shown in the diagram.

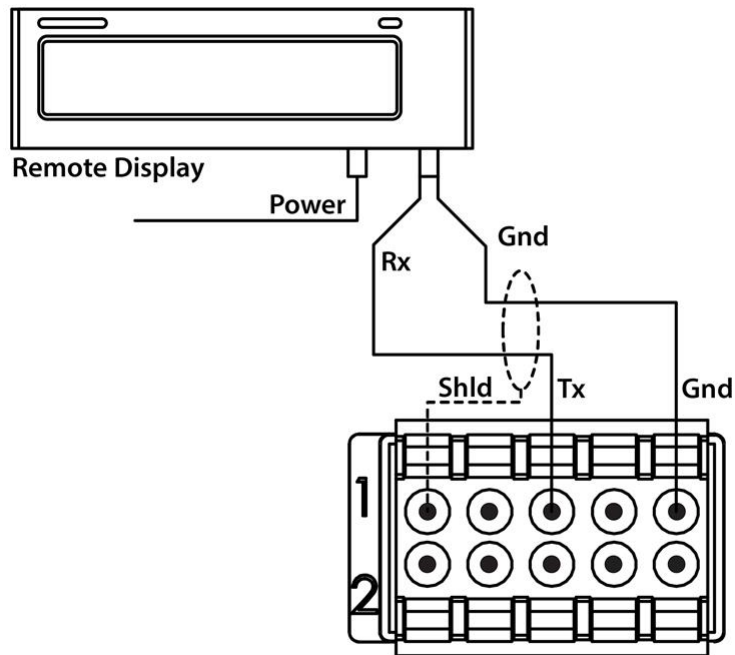

Figure 6: Remote Display Connection

3.2.2 Digital Input and Output Connection (K304, K306)

The C3 series isolated digital inputs should be connected as shown in the diagram below.

The digital outputs are isolated high side drivers. They should be connected as indicated in the diagram below.

The power supply for the outputs should be 5 - 24 VDC, with sufficient current capacity to drive the solenoids. Each digital output has a drive capacity of up to 400 mA. Cable shields should be connected to the indicator shield pins as shown.

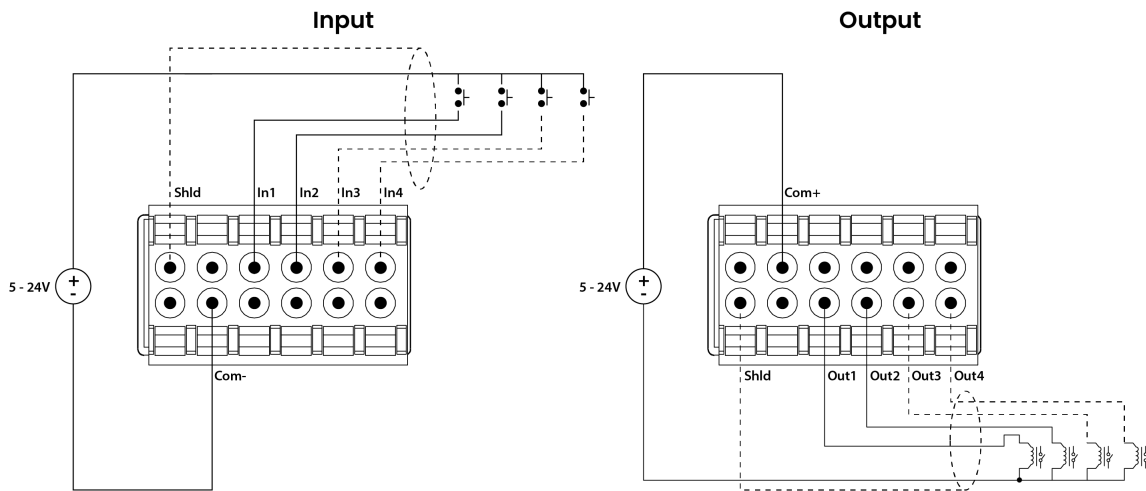

Inputs and Outputs can be combined.

Figure 7: Input and Output Connections

3.3 Optical Communications

A temporary infrared communications link can be established between the instrument and a PC using a rinLINK attachment. This connection can be used to transfer setup and calibration information from a PC.

The PC end of the cable is a standard USB connector. The instrument end of the cable attaches to the left side of the indicator display as shown below.



Figure 8: rinLINK Connection

Warning! The optical coupling head contains a strong magnet and should not be placed near any magnetic storage media (eg. credit cards, floppy disks etc.)

3.4 Accessory Card connection

Optional accessory modules can be connected using the Accessory port to add more functionality to the digital weight indicator. There are two types of accessory cards available.

- Communication cards
- Expansion Cards

These are connected to rear of the indicator using the accessory port.

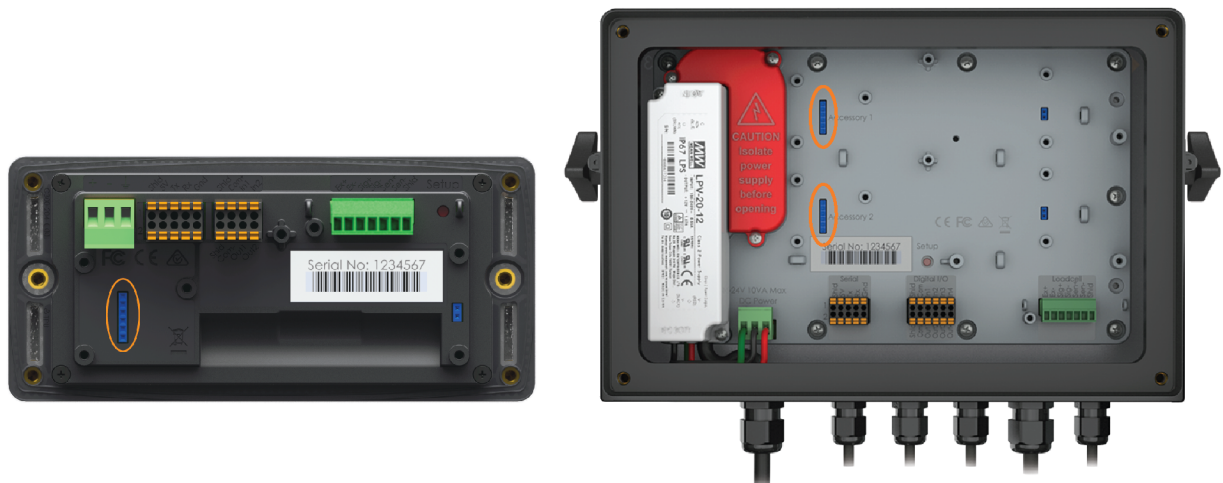

Figure 9: Accessory Card Connection

4. SETUP MENUS

4.1 Accessing Setup Menus

There are two methods to access the Setup Menu areas.

1. Press and hold the <SELECT> keys for two seconds.
2. Press the setup button on the rear of the instrument.

When accessing the Menu area, the instrument will beep twice and back light will turn blue throughout the Menu area and Setup Menus.

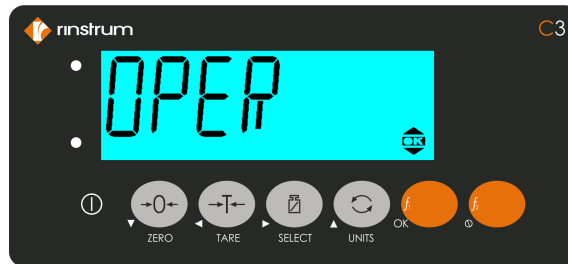

Figure 10: Menu Area

4.2 Language

L2	Short Description	Long Description
LANG	Language	Once the language files are added, the desired language can be selected. <ul style="list-style-type: none"> • EN : English (Default) • DE : German • PL : Polish

4.3 General Options

GEN.OPT		General Options	
L2	L3	Short Description	Long Description
LICENC	Licence		Configures the firmware
	TYPE	Firmware Type	Sets the Firmware type <ul style="list-style-type: none"> • K301 • K304 • K306
	PCODE	Passcode	Configures the instrument passcodes. (Local Function only)
PCODE	Passcode		Sets the instrument Passcodes. There are three levels of Passcode.

	SAFE.PC	Safe Security Passcode for Digital Setup	<p>Allows partial access to Digital Setup (i.e. only non-calibration/trade critical settings can be changed). For the Safe Passcode to have any effect, the FULL.PC Passcode must also be set. The default Passcode setting is 000000 that allows free access. Any other number will enable the Passcode functions and restrict access. The safe Passcode will also give access to operator functions.</p> <ul style="list-style-type: none"> • Range 000000 (Default) to 999999
	FULL.PC	Full Security Passcode for Digital Setup	<p>All settings (including trade critical settings) can be altered from Full Setup. The FULL.PC (Full Passcode) can be set to restrict access to Full Digital Setup. This Passcode is used to prevent unauthorised or accidental tampering in the instrument setup. The default Passcode setting is 000000 that allows free access. Any other number will enable the Passcode functions and restrict access. The full Passcode will also give access to Safe or Operator functions.</p> <ul style="list-style-type: none"> • Range 000000 (Default) to 999999 <p>It is important to note that when restricting full access to setup the Passcode must not be forgotten. It is only possible to circumvent the Passcode at the factory. Care must be taken when setting the Full Digital Setup Passcode to ensure that the instrument does not become permanently locked.</p>
	OP.PC	Operator Passcode	<p>Controls access to various operator functions.</p> <ul style="list-style-type: none"> • Range 000000 (Default) to 999999
TIME (K304, K306)	Time settings		Configure the date and time settings.
	TI.FMT	Time format	<p>Sets the time format for the indicator.</p> <ul style="list-style-type: none"> • 12 (Default) • 24
	DA.FMT	Date format	<p>Set the date format for the indicator.</p> <ul style="list-style-type: none"> • DD.MM.YY • DD.MM.Y4 • MM.DD.YY (Default) • MM.DD.Y4 • YY.MM.DD • Y4.MM.DD
	SET.TI	Time set	<p>Set the time as prompted (Local function only):</p> <ul style="list-style-type: none"> • Hours: Enter hours (01-12 for SETUP:TI.FMT=12, 00 - 23 for SETUP:TI.FMT=24) • Min: Enter minutes (00 - 59) • Sec: Enter seconds (00 - 59) • AM PM: Enter AM or PM for SETUP:TI.FMT=12, not available for SETUP:TI.FMT=24

	SET.DA	Date set	Set the current date as prompted (Local function only): <ul style="list-style-type: none"> • Year: Enter year (2000 - 2099) • Month: Enter month (01 - 12) • Day: Enter day (01 - 31)
KEY.LOC	Front panel key locking		Access to each of the operator functions can be configured separately by locking and unlocking individual keys. The display shows LOCKED to indicate that a key is locked (inactive). Functions protected with a 'Safe' Passcode prompt for the Passcode every time. Entering the Operator Passcode unlocks all operator protected functions so the operator is not continually prompted for the Passcode.
	POWER	Power key lock	<ul style="list-style-type: none"> • AVAIL (Default): Function always available • OPER.PC: Requires a valid Operator Passcode • SAFE.PC: Requires a valid Safe Passcode • LOCKED: Function never available
	ZERO	Fixed function keys	
	TARE		
	SELECT		
	UNIT		
	F1	Programmable function keys	
F2			
DISP	Display settings		These settings control the operation of the display.
	B.LIGHT	Backlight operation	Sets the operation of the backlight. <ul style="list-style-type: none"> • OFF: Backlight is off. • ON (Default): Backlight is on when weight motion, network communications or any keypress is detected. • AUTO: The brightness is lowered automatically to conserve power and the backlight will automatically turn off after a specified duration of inactivity. To turn on again, press the POWER key.
	FREQ	Display update frequency (Hz)	Sets how often the display is updated. <ul style="list-style-type: none"> • 10 (Default) • 5 • 2 • 1
	BL.LVL	Display brightness level	Sets the brightness level of the display. <ul style="list-style-type: none"> • Range 0% (Backlight off) to 100% (maximum brightness) • Default: 60%
POWER	Power settings		Configure power settings of the unit.
	AUT.OFF	Auto power off (min)	The instrument can be set up to automatically power down after set minutes of activity. Weight motion, network communications or any press of the keyboard is enough to keep the instrument powered on. <ul style="list-style-type: none"> • OFF (Default) • 5

			<ul style="list-style-type: none"> • 10 • 20 • 30 • 60 								
	EXT.BAT	External Battery support	Battery voltages: <ul style="list-style-type: none"> • NONE • 4.8V • 12V • 24V • CUSTOM 								
	BAT.VLT	Low Battery Voltage	Sets the voltage at which the low battery error is displayed. (EXT.BAT = CUSTOM) A low battery annunciator will be displayed at 10% above low battery level. The indicator will assume it is on battery power when its input voltage is less than twice the low battery level for the selected battery voltage. Back light is dimmed to ¼ of the back light brightness setting while on battery.								
			<table border="1"> <thead> <tr> <th>Battery Voltage</th> <th>Low Battery Level</th> </tr> </thead> <tbody> <tr> <td>4.8V</td> <td>4V</td> </tr> <tr> <td>12V</td> <td>10V</td> </tr> <tr> <td>24V</td> <td>20V</td> </tr> </tbody> </table>	Battery Voltage	Low Battery Level	4.8V	4V	12V	10V	24V	20V
Battery Voltage	Low Battery Level										
4.8V	4V										
12V	10V										
24V	20V										
BUZZER		Buzzer enable	Configure the Buzzer. <ul style="list-style-type: none"> • OFF: The buzzer is turned off • ON (Default): The buzzer is turned on 								
USR.DEF		Indicator defaults	Set the non-calibration settings to defaults. Local function only.								

4.4 Scale

SCALE	Scale base configuration	Scale Base configuration settings.
L2	L3	Short Description
Description		
BUILD	Scale build	Settings within this Group are used to configure the indicator to suit the current application. It is important to fully set the options within this group before calibration is attempted. Later changes to items within this group may invalidate the current calibration data.

	TYPE	Range type	<p>Range type.</p> <ul style="list-style-type: none"> • SINGLE: Single range • DUAL.I: Dual interval • DUAL.R: Dual range • TRIPL.I: Triple interval • TRIPL.R (Default): Triple range
	DP1	Decimal point position	<p>Sets the location of the decimal point on the display. To avoid confusion, set this parameter first so that all other weight related values are displayed with the decimal point in the correct position.</p> <ul style="list-style-type: none"> • 000000 (Default) • 00000.0 • 0000.00 • 000.000 • 00.0000 • 0.00000
	CAP.1	Capacity of scale/ range 1/ interval 1	<p>Sets the nominal maximum capacity (or full scale) of the scale. This is set in weighing units (e.g. kg, t, etc.), with the decimal point in place. For example, if a scale is to weigh 500.0 kg in 0.5 kg increments, CAP is set to 500.0, and RES is set to 5.</p> <p>If using multiple interval/range, this sets the fullscale capacity of the lowest range/interval.</p> <ul style="list-style-type: none"> • Range: 000001 to 999999 • Default: 005000
	E1	Resolution of scale/ range 1/ interval 1	<p>Sets the resolution (or Count-by) of the display. The resolution is the number by which the indicator will count.</p> <p>If using multiple interval/range, this sets the count-by (or resolution) of the lowest range/interval.</p> <ul style="list-style-type: none"> • 1 (Default) • 2 • 5 • 10 • 20 • 50 • 100
	DP2	Decimal point position	<p>Sets the 2nd range/interval location of the decimal point on the display. To avoid confusion, set DP1 before changing this setting if used. (TYPE=DUAL.I, DUAL.R, TRIPLE.I, TRIPL.R)</p> <ul style="list-style-type: none"> • 000000 (Default) • 00000.0 • 0000.00 • 000.000 • 00.0000 • 0.00000

	CAP.2	Capacity of scale/ range 2/ interval 2	Sets the 2nd range/interval maximum capacity (or full scale) of the scale. This is set in weighing units (e.g. kg, t, etc.), with the DP1 decimal point position in place. (TYPE=DUAL.I, DUAL.R, TRIPLE.I, TRIPL.R) <ul style="list-style-type: none"> • Range: 000001 to 999999 • Default: 020000
	E2	Resolution of scale/ range 2/ interval 2	Sets the 2nd range/interval resolution (or Count-by) of the display. (TYPE=DUAL.I, DUAL.R, TRIPLE.I, TRIPL.R) <ul style="list-style-type: none"> • 1 • 2 (Default) • 5 • 10 • 20 • 50 • 100
	DP3	Decimal point position	Sets the 3rd range/interval location of the decimal point on the display. To avoid confusion, set DP1 then DP2 before changing this setting if used. (TYPE=DUAL.I, DUAL.R, TRIPLE.I, TRIPL.R) <ul style="list-style-type: none"> • 000000 (Default) • 00000.0 • 0000.00 • 000.000 • 00.0000 • 0.00000
	CAP.3	Capacity of scale/ range 3/ interval 3	Sets the 3rd range/interval maximum capacity (or full scale) of the scale. This is set in weighing units (e.g. kg, t, etc.), with the DP1 decimal point position in place. (TYPE=DUAL.I, DUAL.R, TRIPLE.I, TRIPL.R) <ul style="list-style-type: none"> • Range: 000001 to 999999 • Default: 050000
	E3	Resolution of scale/ range 3/ interval 3	Sets the 3rd range/interval resolution (or Count-by) of the display. (TYPE=DUAL.I, DUAL.R, TRIPLE.I, TRIPL.R) <ul style="list-style-type: none"> • 1 • 2 • 5 (Default) • 10 • 20 • 50 • 100
	P.UNIT	Primary weighing units	Sets the primary weighing units of the scale for display and printing. <ul style="list-style-type: none"> • NONE • kg: Kilograms • lb: Pounds (Default) • t: Tonnes • tn: Tons • g: Grams

			<ul style="list-style-type: none"> • oz: Ounces • N: Newton • kN: Kilo newton
	UNIT.2	Secondary weighing units	<p>Sets the secondary weighing units for the scale.</p> <ul style="list-style-type: none"> • OFF: Off (Default) • g: Grams • kg: Kilograms • t: Tonnes • lb: Pounds • oz: Ounces • lb oz: Pounds Ounces • tn: Tons • CUSTOM: Custom units
	UNIT.3	Tertiary weighing units	<p>Sets the tertiary weighing units for the scale.</p> <ul style="list-style-type: none"> • OFF: Off (Default) • g: Grams • kg: Kilograms • t: Tonnes • lb: Pounds • oz: Ounces • lb oz: Pounds Ounces • tn: Tons
	D.UNIT	Custom unit	<p>Set the symbols to use for a custom defined unit on the instrument display (UNIT.2=CUSTOM).</p> <ul style="list-style-type: none"> • NONE (Default) • L: Lower case "l" for litres • ARROW.U: Upper unit arrow
	U.NAME	Custom unit name	<p>Sets the name of the custom unit (UNIT.2=CUSTOM).</p>
	FACTOR	Conversion factor	<p>Conversion factor for the custom unit (UNIT.2=CUSTOM).</p> <ul style="list-style-type: none"> • Range: 0.001 to 999.999 • Default: 1.000
	HI.RES	x10 expanded mode	<p>Sets the instrument to display weight at 10 times resolution. This is intended for test purposes in trade applications but may be used for industrial weighing. This mode is indicated by the flashing of the unit's annunciator.</p> <ul style="list-style-type: none"> • OFF (Default) • ON
OPTION	Scale options		

	USE	Trade use	<p>This is where the basic use of the scale is set. This setting configures the instrument for Industrial, OIML, or NTEP operation.</p> <ul style="list-style-type: none"> • INDUST: Industrial (no standard) • OIML: OIML trade mode • NTEP (Default): NTEP trade mode
	FILTER	Reading average	<p>The instrument can average a number of consecutive readings when calculating the displayed weight. This is used to dampen unwanted weight fluctuations caused by vibrations or dynamic forces. High settings will stabilize the display at the expense of rapid response to sudden weight changes.</p> <ul style="list-style-type: none"> • OFF • 0.5 • 1.0 (Default) • 1.5 • 2.0 • 2.5 • 3.0 • 3.5 • 4.0
	JITTER	Anti-jitter average reset	<p>Sets the reset threshold for the anti-jitter filter. Options are:</p> <ul style="list-style-type: none"> • OFF (Default): Anti-jitter average disabled • FINE : Small changes will reset the filter • COARSE: Large changes are required to reset the filter
	MOTION	Motion detection sensitivity	<p>Sets how much weight variation over a defined time period is allowed before the displayed weight is deemed to be unstable. This setting is given as $x_d - y_t$ where weight change of more than x divisions in y seconds will trigger motion. This value is displayed as weight change (0.5 or 1.0 graduations) per second. When set to OFF, the Motion Detection is ignored and ZERO, TARE and PRINT actions are instantaneous.</p> <ul style="list-style-type: none"> • OFF, 0.5-1.0, 1.0-1.0, 2.0-1.0, 3.0-1.0, 5.0-1.0, 0.5-0.5, 1.0-0.5, 2.0-0.5, 3.0-0.5, 5.0-0.5, 0.5-0.2, 1.0-0.2, 2.0-0.2, 3.0-0.2, 5.0-0.2 (graduations per second) • Default: 0.5-1.0 (0.5 graduations per second)
	Z.RANGE	Allowable zero operating range	<p>This setting restricts the range over which the Zero functions can operate.</p> <ul style="list-style-type: none"> • OFF • -2_2 • -1_3 (-1% to +3%) (Default) • -10_10 • -20_20 • FULL

	Z.TRACK	Zero tracking sensitivity	<p>Zero tracking allows the display to adjust for minor changes in the zero balance of the scale. When enabled, the instrument will track weight readings within the zero 'dead' band back to exactly zero at a maximum rate of graduations per second.</p> <ul style="list-style-type: none"> • OFF (Default) • 0.5 • 1 • 2 • 3 • 5
	Z.INIT	Initial-zero on start-up	<p>Enables the zero-on-start-up feature. When enabled, a zero will be performed as part of the instrument start-up procedure if the scale is within the zero range. This function can be used to automatically ZERO the indicator during power-up. The amount of weight that can be zeroed is limited to +/- 10% of full scale.</p> <ul style="list-style-type: none"> • ON • OFF (Default)
	Z.BAND	Zero 'dead' band	<p>Sets the weight range around zero which will be considered zero for application purposes. This is an adjustable margin either side of true zero that defines the zero 'dead' band. The zero 'dead' band is used by the automated functions to determine zero load (e.g. a setting of 4 specifies that readings between -4.5 and 4.5 are considered to be zero). When the displayed weight reading is within this band the instrument displays the zero band annunciator. Settable over the full weight range. Always enter a number in multiples of display units.</p> <ul style="list-style-type: none"> • Range: -1 to 999999 • Default: 0 (i.e. -0.5 to 0.5 graduations)
	R.ENTRY	Rear entry	<p>Full access via the rear setup button only. This option is only available when the rear setup button has been used to access the menu system.</p> <ul style="list-style-type: none"> • ON • OFF (Default)
	PT.CLR	Preset tare clear	<p>Sets if the preset tare is cleared by the tare key or not.</p> <ul style="list-style-type: none"> • OFF: Preset tare is not cleared by the tare key. Both preset tare and user tare will be active at the same time. • TARE (Default): Preset tare is cleared by the tare key.
CAL	Scale calibration		<p>Items within this group perform various calibration routines. Certain items in the Scale Build can affect the calibration of the scale. Always check that these sections are correctly configured to suit the</p>

		current application before attempting to calibrate the scale.
	ZERO	Zero calibration Select to perform Zero Calibration. While the zeroing is in progress the display will show Z.in P
	SPAN	Span calibration Perform a span calibration. A zero calibration should be done before doing a span calibration. While the span calculation is in progress the display will show S.in P.
	ED.LIN	Edit linearisation points Select to view linearisation setup and start linearisation routines. While linearisation is in progress the display will show L.in P.
	CLR.LIN	Clear linearisation points Select to view linearisation setup and select linearisation points to clear.
	DIR.ZER <i>(K304, K306)</i>	Direct mV/V zero calibration Enter signal strength (in mV/V) of zero calibration directly.
	DIR.SPN <i>(K304, K306)</i>	Direct mV/V span calibration Enter the signal strength (in mV/V) of fullscale directly. No test weights required.
	DEF.CAL	Default calibration (all scale settings to defaults) Restore instrument to default factory calibration and reset all items in the SCALE menu to defaults.
GRAV.	Gravity	Used to compensate for the change in gravitational acceleration between locations.
	G.COMP	Gravity compensation Enables the gravitational acceleration compensation feature. <ul style="list-style-type: none"> • OFF: Disable gravity compensation • ON (Default): Enable gravity compensation
	G.FACT	Factory gravitational acceleration Sets the gravitational acceleration of the factory location. <ul style="list-style-type: none"> • Range: 9.750 to 9.860 • Default: 9.810
	G.INST	Installation gravitational acceleration Sets the gravitational acceleration of the installation location. <ul style="list-style-type: none"> • Range: 9.750 to 9.860 • Default: 9.810
	G.FIRST	Gravitational acceleration first setting When set, the indicator will prompt for the installation gravitational acceleration on the next power on. <ul style="list-style-type: none"> • OFF (Default): Disable prompt for installation gravitational acceleration on the next power on • ON: Enable prompt for installation gravitational acceleration on the next power on
QA <i>(K304, K306)</i>	Quality assurance	Configure the quality assurance feature. If active the instrument displays a 'QA DUE' warning after the date limit has expired.

	QA.OPT	QA enable	Turn QA feature on or off. <ul style="list-style-type: none"> • ON • OFF (Default)
	YEAR	QA expiry date	Enter QA expiry date - year <ul style="list-style-type: none"> • Range: 2020 (Default) - 2099 This item is trade critical and will affect the calibration counter(s) if changed.
	MONTH	QA expiry date	Enter QA expiry date - month <ul style="list-style-type: none"> • Range: 1 (Default) - 12 This item is trade critical and will affect the calibration counter(s) if changed.
	DAY	QA expiry date	Enter QA expiry date - day <ul style="list-style-type: none"> • Range: 1 (Default) - 31 This item is trade critical and will affect the calibration counter(s) if changed.

4.5 Serial

SERIAL	Serial output (K301 only supports ACC1)		Serial output settings. ACC2 is only available for C35x.	
L2	L3	L4	Short Description	Long Description
HEADER			Printout header	Sets the print docket header.
FOOTER			Printout footer	Sets the print docket footer.
SER1- SER2 ACC1- ACC2	Serial port 1-2 Accessory port 1-2			Settings for serial port 1-2. Settings for accessory port 1-2.
	BAUD		Baud rate	Sets the baud rate for the port. <ul style="list-style-type: none"> • 1200 • 2400 • 4800 • 9600 (Default for SER1-SER2) • 19200 • 38400 • 57600 • 115200 (Default for ACC1-ACC2)
	DATA		Data bits	Sets the number of data bits for the port. <ul style="list-style-type: none"> • 8 (Default) • 7
	PARITY		Parity	Sets the parity for the port. <ul style="list-style-type: none"> • NONE (Default) • EVEN • ODD
	STOP		Stop bits	Sets the number of stop bits for the port. <ul style="list-style-type: none"> • 1 (Default) • 2
	SER.NET <i>(K304, K306)</i>	Serial network		Configure the serial networking support.
		ADDR	Network address	Address of instrument <ul style="list-style-type: none"> • Range: 1 (Default) - 31
		TYPE	Protocol type	Sets the network protocol type. <ul style="list-style-type: none"> • NONE • RINCMD (Default) • SIMPLE • MIMIC
	SER.AUT	Automatic serial output		Settings for automatic serial outputs.
		FORMAT	Format	Sets the data format. <ul style="list-style-type: none"> • FMT.A (Default) to FMT.I and CUSTOM
		AUTO.SPD	Serial output frequency	Sets the serial output frequency <ul style="list-style-type: none"> • SINGLE (Default) • FULL • 10Hz

				<ul style="list-style-type: none"> • 5Hz • 2Hz • 1Hz
		SOURCE	Weight data source	<p>Sets the weight data to send.</p> <ul style="list-style-type: none"> • P.GROSS • P.NET • P.DISP • P.NET.PT • D.GROSS • D.NET • D.DISP (Default) • D.NET.PT
PRINT (K304, K306)	Printout settings			Configures the printout settings.
	FORMAT	Printout format		<p>Sets the printout format.</p> <ul style="list-style-type: none"> • FMT.A (Default) • FMT.B • CUSTOM
	TYPE	Printout type		<p>Sets the printout type.</p> <ul style="list-style-type: none"> • NONE • RECORD (Default) • DOCKET
	ACCUM	Accumulation		<p>Enables total accumulation.</p> <ul style="list-style-type: none"> • OFF • ON (Default) <p>When set to ON, it adds the current weight to the TOTAL for each print event. Note there is one accumulation for the instrument but there is a total for each unit, Gross and Net..</p>
	AUTO	Automatic printing		<p>Sets whether printing occurs automatically.</p> <ul style="list-style-type: none"> • NO (Default) • YES
	IL.TYPE	Interlock type		<p>Sets the type of printing interlock to be used.</p> <ul style="list-style-type: none"> • NONE (Default): No interlock type • MOTION: Printing is enabled every time the scale becomes stable. • I.LOCK: Printing is enabled when the weight is stable after a weight movement larger than the interlock weight. • RET.Z: Printing is enabled after the scale has returned to zero and is stable at a reading other than zero.
	I.LOCK	Interlock weight		<p>Sets the interlock weight.</p> <ul style="list-style-type: none"> • Range 000000 (Default) to 999999
	P.WIDTH	Page width		<p>Sets the page width. A setting of zero disables page width checking.</p>

				<ul style="list-style-type: none"> Range 0 (Default) to 80
		SP.TOP	Top spacing	<p>Sets the number of blank lines added to the top of the print out.</p> <ul style="list-style-type: none"> Range 0 (Default) to 10
		SP.LEFT	Left spacing	<p>Sets the number of leading spaces added to each line of the print out.</p> <ul style="list-style-type: none"> Range 0 (Default) to 10
		SP.BOT	Bottom spacing	<p>Sets the number of blank lines added to the bottom of the print out.</p> <ul style="list-style-type: none"> Range 0 (Default) to 10

4.6 Set Points (K304 - 8 Basic, K306 - 8 Advanced)

SETP	Setpoint settings		Configure setpoints.
L2	L3	Short Description	Long Description
SETP1- SETP8	Setpoint 1 to 8		Configuration settings for setpoint 1-8
	TYPE	Setpoint type	<p>Set set-point type. Options are:</p> <ul style="list-style-type: none"> OFF: Disabled (default) ON: Always active OVER: Weight over set-point UNDER: Weight under set-point COZ: Center of zero status ZERO: Zero band status NET: Gross/net status MOTION: Motion status ERROR: Error status C.W.HI: Checkweigh high status C.W.OK: Checkweigh OK status C.W.LO: Checkweigh low status W.IN: Weigh in W.OUT: Weigh out BUZZER: Enable buzzer
	LOGIC	Output logic	<p>Output logic.</p> <ul style="list-style-type: none"> HIGH (Default): Forces the output to follow the setpoint activity, the output will be on when the setpoint is active. LOW: Forces the output to the reverse of the setpoint activity, the output will be off when the setpoint is active.

TIMING (K306)	Output timing	Select the timing which is applied to the setpoint output. <ul style="list-style-type: none"> • LEVEL (Default): Output is active when setpoint is active and reset is not active. • EDGE: Output is active when setpoint is active. • LATCH: will stay inactive after reset until the next setpoint transition from inactive to active.
TARGET	Target weight	Sets the target weight. The flight weight must be taken into consideration when setting the target weight (TYPE=OVER, UNDER, W.IN, W.OUT). <ul style="list-style-type: none"> • Range : -999999 to 999999 • Default : 0
FLIGHT (K306)	Flight weight	Sets the expected weight of material in flight (TYPE=OVER, UNDER, W.IN, W.OUT). <ul style="list-style-type: none"> • Range 000000 to 999999 • Default : 0
HYS (K306)	Hysteresis	Hysteresis defines the amount of weight required for an active setpoint to become inactive again (TYPE=OVER, UNDER, W.IN, W.OUT). A value of 0 still allows for 0.5 graduations of hysteresis. <ul style="list-style-type: none"> • Range 000000 to 999999 • Default : 0
ALARM	Setpoint alarm	Alarms are triggered when the setpoint is active. <ul style="list-style-type: none"> • NONE (Default): no alarm • SINGLE: single BEEP • DOUBLE: double BEEP • FLASH: flash display
B.LIGHT	Backlight color	Sets the backlight color to display when the setpoint is active. <ul style="list-style-type: none"> • NONE (Default) • WHITE • RED • GREEN • BLUE • ORANGE • PURPLE • TEAL • AMBER • PINK
SOURCE	Source weight	Select which weight values the setpoint checks against the target weight (TYPE=OVER, UNDER, ZERO, W.IN, W.OUT). <ul style="list-style-type: none"> • GROSS (Default) : Gross weight always • NET: Net weight always • GR.or.NT: Gross or Net depending on which one is displayed. • PIECE: Gross or Net Piece count depending on which one is displayed

			<ul style="list-style-type: none"> NET.PT: Net preset tare
	RESET <i>(K306)</i>	Disable setpoint	Input to disable the setpoint. <ul style="list-style-type: none"> NONE (Default), IN 1 to IN 8
	NAME	Name of the setpoint	Setpoint name. Used in the target function key to identify the setpoint.

4.7 App

APP			
L2	L3	Short Description	Long Description
P.COUNT <i>(K304, K306)</i>		Piece count	Counting functions are preformed by P.COUNT special function. <ul style="list-style-type: none"> OFF (Default) WEIGHT: Allows the operator to enter piece weight directly. RESAMP: Allows you to keep adding pieces to adjust the sample size.
CHECK.W <i>(K304, K306)</i>		Check weighing	This allows the gross/net weight, displayed weight or pieces to be chosen as the source for the setpoint operation. This allows the over, under and tartget limits to be linked to gross/net weights, pieces values.
	MODE	Check weighing mode	Configures the checkweighing behaviour. <ul style="list-style-type: none"> OFF (Default): Disablecheckweighing ABS: Enable absolute checkweighing REL: Enable relative checkweighing
	SOURCE	Check weighing source	This allows to choose what weight/Pieces value to be used to set TARGET, HIGH and LOW levels (MODE=ABS, REL). <ul style="list-style-type: none"> GROSS NET GR.or.NT (Default) PIECE NET.PT
	CTRL	Check weighing control	Sets when the check weighing function is active (MODE=ABS, REL). <ul style="list-style-type: none"> NONE (Default) ZERO MOTION
	HIGH	Check weighing upper level weight	Sets the higher threshold of the check weigh range (MODE=ABS). <ul style="list-style-type: none"> Range: -99999 to 999999 Default: 001100

	LOW	Check weighing lower level weight	Sets the lower threshold of the check weigh range (MODE=ABS). <ul style="list-style-type: none"> • Range -99999 to 999999 • Default: 000900
	TARGET	Check weighing target	Sets the target check weight (MODE=REL) <ul style="list-style-type: none"> • Range -99999 to 999999 • Default: 005000
	TOL.HI	Check weighing upper tolerance	Sets the upper tolerance for relative check weighing (MODE=REL). <ul style="list-style-type: none"> • Range: -99999 to 999999 • Default: 001100
	TOL.LOW	Check weighing lower tolerance	Sets the lower tolerance for relative check weighing (MODE=REL). <ul style="list-style-type: none"> • Range -99999 to 999999 • Default: 000900
A.TARE (K304, K306)	Auto tare		The option is used to enable the automatic tare feature. This feature when enabled will cause the indicator to be tared whenever the weight is motionless above the auto-tare threshold and has been below the auto-tare threshold since the last auto-tare.
	A.TARE	Auto tare input	Input to set the preset tare to the current gross weight. <ul style="list-style-type: none"> • OFF (Default) • ON.CLR • ON.AUTO
	CLR.DLY	Clear delay (s)	Delay before returning to gross weight when inside the zero band. <ul style="list-style-type: none"> • Range 0.0 to 10.0 • Default: 1.0
	THRESH	Weight threshold	Weight threshold to reach before automatically taring. <ul style="list-style-type: none"> • Range: 0 (Default) to 999999
F1, F2 KEYS	Special function Key 1-2		Configures special function keys 1-2
	TYPE	Function type	Sets the function type. <ul style="list-style-type: none"> • NONE (Default) • PRINT: Triggers a printout (K304, K306) • SINGLE: Triggers a single serial weight transmission • TEST: Display test • UNITS: Triggers unit switching • HOLD: Manual hold • PK.HOLD: Peak hold (K304, K306) • REM.KEY: Remote key operation (K304, K306) • BLANK: Blanking input (K304, K306) • HI.RES: High resolution mode toggle • LIVE: Implements live weighing • ACCUM: Totalisation (K304, K306)

		<ul style="list-style-type: none"> • TARGET: Target (K304, K306) • FUNC.EN: Function enable (K304, K306) • MED.HLD: Medical hold (K304, K306) • NET.HLD: Net Hold (K304, K306)
PRT.OUT	Printout	<p>Configuration of the PRINT Special Function (TYPE=PRINT). Printouts are configured in the SERIAL menu.</p> <ul style="list-style-type: none"> • SER 1 (Default) • SER 2 • ACC 1 • ACC 2 (Available for C35x)
AUT.OUT	Auto output serial	<p>Choose which Auto Output Serial service to trigger (TYPE=SINGLE). Single serial outputs are similar to printing but do not support any interlocking or totalising functions.</p> <ul style="list-style-type: none"> • SER 1 (Default) • SER 2 • ACC 1 • ACC 2 (Available for C35x)
P.HOLD <i>(K304, K306)</i>	Peak hold	<p>A peak hold key/input implements a peak hold where the largest absolute weight, either positive or negative is stored and displayed (TYPE=PK.HOLD).</p> <ul style="list-style-type: none"> • ALWAYS (Default) • STABLE
REM.KEY <i>(K304, K306)</i>	Remote key function	<p>Allows for external inputs to be used to trigger instrument key functions (TYPE=REM.KEY). The external 'keys' operate even if the instrument keys are locked and never require Operator or Setup passcodes to be entered.</p> <ul style="list-style-type: none"> • NONE (Default) • ZERO • TARE • SELECT
BLANK <i>(K304, K306)</i>	Blanking function	<p>Blanking functions enable the detection of external inputs to be used to block instrument operation by blanking the screen and blocking key functions (TYPE=BLANK).</p> <ul style="list-style-type: none"> • DASH (Default): Fill instrument display with '-' characters • BLANK: completely blank instrument display
DELAY	Time delay (s)	<p>The time in seconds that the indicator will wait after the threshold weight is exceeded before it starts collecting weight samples (TYPE=LIVE).</p> <ul style="list-style-type: none"> • Range: 0.0 to 20.0 • Default: 1.0
SAMPLE	Sample time	<p>The number of seconds worth of weight samples to collect (TYPE=LIVE).</p>

			<ul style="list-style-type: none"> • Range: 1 to 20 • Default: 4
	TOL	Number of discards	<p>Available when TYPE=LIVE. Indication of what percentage of noisy samples will be discarded from upper and lower ends.</p> <ul style="list-style-type: none"> • Range: 0 to 75 • Default: 30
	RETRIG	Retrigger percentage	<p>This is the percentage that the weight on the scale must change by to restart the live weighing process once a held weight has been captured (TYPE=LIVE). A value of 0 means that automatic retriggering is disabled.</p> <ul style="list-style-type: none"> • Range: 0 (Default) to 30
	THRESH	Threshold weight	<p>The weight to be exceeded before the indicator will start the livestock weighing function (TYPE=LIVE).</p> <ul style="list-style-type: none"> • Range -99999 to 999999 • Default: 0
	PRINT	Printout	<p>Configuration of the PRINT Function (TYPE=LIVE). Printouts are configured in the SERIAL menu.</p> <ul style="list-style-type: none"> • NONE (Default) • SER 1 • SER 2 • ACC 1 • ACC 2 (Available for C35x)
IN 1 - IN 4 (K304, K306)	Input 1-4		Configures inputs 1 to 4. C32x has only two inputs and C35x has all 4 inputs.
	TYPE	Input type	<p>Sets the input type.</p> <ul style="list-style-type: none"> • NONE (Default) • PRINT: Triggers a printout • SINGLE: Triggers a single serial weight transmission • TEST: Display test • UNITS: Triggers unit switching • HOLD: Manual hold • PK.HOLD: Peak hold • REM.KEY: Rremote key operation • BLANK: Blanking input • HI.RES: High resolution mode toggle • LIVE: Implements live weighing • ACCUM: Totalisation • TARGET: Target • FUNC.EN: Function enable • MED.HLD : Medical hold • NET.HLD : Net Hold
	PRT.OUT	Printout	<p>Configuration of the PRINT Special Function (TYPE=PRINT). Printouts are configured in the SERIAL menu.</p> <ul style="list-style-type: none"> • SER 1 (Default)

		<ul style="list-style-type: none"> SER 2 ACC 1 ACC 2 (Available for C35x)
AUT.OUT	Auto output serial	<p>Choose which Auto Output Serial service to trigger (TYPE=SINGLE). Single serial outputs are similar to printing but do not support any interlocking or totalising functions.</p> <ul style="list-style-type: none"> SER 1 (Default) SER 2 ACC 1 ACC 2 (Available for C35x)
P.HOLD <i>(K304, K306)</i>	Peak hold	<p>A peak hold key/input implements a peak hold where the largest absolute weight, either positive or negative is stored and displayed (TYPE=PK.HOLD).</p> <ul style="list-style-type: none"> ALWAYS STABLE (Default)
REM.KEY <i>(K304, K306)</i>	Remote key function	<p>Allows for external inputs to be used to trigger instrument key functions (TYPE=REM.KEY). The external 'keys' operate even if the instrument keys are locked and never require Operator or Setup passcodes to be entered.</p> <ul style="list-style-type: none"> NONE (Default) ZERO TARE SELECT
BLANK <i>(K304, K306)</i>	Blanking function	<p>Blanking functions enable the detection of external inputs to be used to block instrument operation by blanking the screen and blocking key functions (TYPE=BLANK).</p> <ul style="list-style-type: none"> DASH (Default): Fill instrument display with '-' characters BLANK: completely blank instrument display
DELAY	Time delay (s)	<p>The time in seconds that the indicator will wait after the target weight is exceeded before it starts collecting weight samples (TYPE=LIVE).</p> <ul style="list-style-type: none"> Range: 0.0 to 20.0 Default: 1.0
SAMPLE	Sample time	<p>The number of seconds worth of weight samples to collect (TYPE=LIVE).</p> <ul style="list-style-type: none"> Range: 1 to 20 Default: 4
TOL	Number of discards	<p>Available when TYPE=LIVE. Indication of what percentage of noisy samples will be discarded from upper and lower ends.</p> <ul style="list-style-type: none"> Range: 0 to 75 Default: 30

	RETRIG	Retrigger percentage	This is the percentage that the weight on the scale must change by to restart the live weighing process once a held weight has been captured (TYPE=LIVE). A value of 0 means that automatic retriggering is disabled. <ul style="list-style-type: none"> • Range: 0 (Default) to 30
	THRESH	Threshold weight	The weight to be exceeded before the indicator will start the livestock weighing function (TYPE=LIVE). <ul style="list-style-type: none"> • Range -99999 to 999999 • Default: 0
	PRINT	Printout	Configuration of the PRINT Function (TYPE=LIVE). Printouts are configured in the SERIAL menu. <ul style="list-style-type: none"> • NONE (Default) • SER 1 • SER 2 • ACC 1 • ACC 2 (Available for C35x)

4.8 Test

TEST		
L2	Short Description	Long Description
DISP	Display test	Test the display by displaying all segments turned on and off.
MVV	mV/V test mode	Show the loadcell signal in mV/V.
OUT.TST <i>(K304, K306)</i>	Test digital outputs	Test digital outputs by setting outputs on or off. Use the Zero and Tare keys to select the output, and the Units and Gross/Net keys to toggle the value.
INP.TST <i>(K304, K306)</i>	Test digital inputs	Display the digital input states.
OL.CNT	Overload count	Shows the number of times the instrument has been overloaded or underloaded by at least 50% of fullscale.
OL.CLR	Clear overload count	Clear the overload counter.
UVPD	Micro volt per division	Display the uV per division value

4.9 Analog Output (K306)

ANL.OUT	analog Output		Configures the operation of the analog transmission.
L2	L3	Short Description	Long Description
TYPE	analog Output Type		Sets the analog output to current (4-20mA) or voltage (0-10V) mode. <ul style="list-style-type: none"> • CURRENT(Default) • VOLT
SOURCE	Input Source		Determines what weight readings are to be sent depending on which is selected and currently displayed on the main display. <ul style="list-style-type: none"> • GROSS (Default) • NET • GR.orNT
ABS	Absolute Weight		Allows negative weight readings to be treated as positive values for the purposes of the analog output transmission. Especially useful when transmitting negative net readings in WEIGH-OUT applications. <ul style="list-style-type: none"> • NO (Default) • YES
CLIP	analog Output Clip Enable		Determines if the analog output is allowed to extend past the nominal limits. If CLIP is on, the output will not go below 0V or above 10V for voltage outputs. For current output the limits are 4mA and 20mA. If CLIP is off the voltage can extend an extra 0.5 Volts or so past the limits and the current can extend from 0mA to 24mA. <ul style="list-style-type: none"> • NO (Default) • YES
RANGE	Weight Range		Specify the weight range that corresponds to the analog output range. Helps increase the resolution of the analog output over the weight range of interest <ul style="list-style-type: none"> • FULLSC (Default) • CUSTOM
WGT.LO	Weight Low		Weight corresponding to the lower analog limit. (RANGE=CUSTOM) (eg: 0 or 4mA) <ul style="list-style-type: none"> • Default: 0 • Range: -99999 to 999999
WGT.HI	Weight High		Weight corresponding to the higher analog limit. (RANGE=CUSTOM) (eg: 10V to 10mA) <ul style="list-style-type: none"> • Default: 10000 • Range: -99999 to 999999
ANL.CAL	analog Output Calibration		
	ADJ.LO	Calibrate analog Output	Calibrate 4mA or 0V analog output. Use the UP and DOWN keys to adjust the calibration.

	ADJ.HI		Adjust 20mA or 10V analog output. Use the UP and DOWN keys to adjust the calibration.
OUT.TST	analog Output Test		The analog output can be driven to any value using the OUT.TST function. Use the UP and DOWN arrows to move the output up and down to test that the values shown on the instrument display match the readings taken externally.





4.10 DSD (K304, K306)

DSD		
L2	Short Description	Long Description
DSD.EN	Enable DSD	Enables and disables the DSD. Options are: <ul style="list-style-type: none"> • OFF (Default) • ON
AUTO.C	Auto Clear	Sets whether the DSD will automatically write over the oldest records when it becomes full. <ul style="list-style-type: none"> • OFF • ON (Default)
DSD.STR <i>(K306)</i>	DSD String	Custom string to be stored along with the traceable data when the DSD is written. This accepts all print tokens.

4.11 End

Save and Close

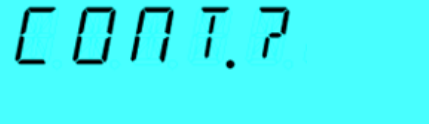
5. QUICK CALIBRATION

 SELECT	<p>LONG PRESS SELECT KEY, OPER WILL BE DISPLAYED.</p>	
 SELECT	<p>SHORT PRESS SELECT TWICE TO DISPLAY FULL.</p>	
 OK	<p>PRESS F1 [OK] KEY TO ACCEPT FULL SETUP.</p>	
 ZERO	<p>PRESS ZERO KEY 2 TIMES TO GET TO SCALE.</p>	
 TARE	<p>PRESS TARE KEY THREE TIMES TO GET TO CAL. SCALE MUST BE EMPTY.</p>	
 SELECT	<p>PRESS THE SELECT KEY ONCE THEN PRESS F1 TWICE. ('Z IN P'; ZERO CAL CAPTURE)</p>	
 	<p>PRESS F2 KEY ONCE THEN PRESS SELECT TO SHOW SPAN. PRESS F1 KEY ONCE TO ENTER SPAN.</p>	
 OK	<p>SPAN CAL: (APPLY WEIGHTS) PRESS F1 KEY TO ACCEPT SPAN WEIGHTS.</p>	
<p>ENTER WEIGHT VALUE</p>		 USE ARROW KEYS AND OK TO ENTER
 OK	<p>PRESS F1 KEY TO CAPTURE SPAN. ('S IN P'; SPAN CAL CAPTURE)</p>	
 	<p>PRESS F2 ONCE TO BACK OUT OF SPAN CAL THEN <u>PRESS AND HOLD POWER & F2</u> TO SAVE AND EXIT.</p>	

6. APPENDIX - ERROR MESSAGES

Overview

A number of error messages may be displayed to warn of operation outside of the acceptable limits. These messages may appear on either the primary or the secondary display.

Short messages (XXXXXX) will appear as a single message. Longer messages (XXXXXX) (YYYYYY) will appear on the display in two parts, first the (XXXXXX) part, then the (YYYYYY) part.

6.1 Weighing Errors

These messages show status messages or errors that may occur during normal weighing operation.

Error	Description	Resolution
(U.LOAD)	The weight is below the minimum allowable weight reading.	Increase the weight or decrease the minimum allowable weight reading.
(O.LOAD)	The weight is above the maximum allowable weight reading. Warning - overloading may damage mechanical scale elements.	Check the condition of load cell connections. Check for damaged load cell.
(ERROR) (RANGE)	The weight reading is beyond the limit set for Zero operation. The operation of the <ZERO> key is limited in the setup during installation. The indicator cannot be Zeroed at this weight.	Increase the Zero Range (Z.RANGE) or use the <TARE> key instead.
(ERROR) (MOTION)	Scale motion has prevented a <ZERO> or <TARE> operation from occurring on command.	Try the operation again once the scale is stable.
(ERROR) (ADC)	An error with the ADC has prevented a <ZERO> or <TARE> operation from occurring on command.	Ensure loadcell cabling is correct.

6.2 Setup Errors



These messages show status messages or errors that may occur during the instrument setup.

Error	Description	Resolution
(ENTRY) (DENIED)	When accessing setup, more than three attempts have been made with the incorrect passcode.	Turn the instrument off. When the instrument is turned back on, enter the correct passcode to access setup.
(WR DENIED) (RD DENIED)	The instrument may be in Safe Setup and an item that needs Full Setup has been selected for editing.	Access Full Setup to access this item.

6.3 Diagnostic Errors

The instrument continually monitors the condition of the internal circuits. Any faults or out-of-tolerance conditions are shown on the display as an E type error message. In the table below the following terms are used:

- Check: This item can be checked on site by service personnel.
- Return for Service: The instrument must be returned for factory service.

Error	Description	Resolution
(E0001)	The power supply voltage is too low.	Check supply
(E0002)	The power supply voltage is too high.	Check scale / cables
(E0004)	Positive sense voltage out of range.	Check scale connections and refer section 4/6 wire connection 
(E0008)	Negative sense voltage out of range.	Check scale connections and refer section 4/6 wire connection 
(E0010)	Temperature is outside of allowable limits	Check location
(E0020)	Module Error	Replace Module
(E0080)	Language file corrupted	Reload translation files
(E0200)	The calibration information has been lost.	Re-calibrate
(E0400)	The factory information has been lost.	Return for Service
(E0800)	Application settings have been set to defaults.	Check and re-enter application settings
(E2000)	ADC Out of Range Error. This may be caused from a broken load cell cable.	Check BUILD:CABLE setting. Check load cell cable, wiring, etc.
(E00100)	The digital setup information has been lost.	Re-enter setup and Check settings
(E01000)	Change in ADC or DSD library checksum	Re-enter setup
(E04000)	Runtime database has been lost	Check zero and Tare settings

The E type error messages are additive. For example if instrument is running off batteries and the temperature drops, the battery voltage may be too low. The resulting error messages will be E 0011 (0001 + 0010). The numbers add in hexadecimal as follows:

1 - 2 - 3 - 4 - 5 - 6 - 7 - 8 - 9 - A - B - C - D - E - F
 (For example, 2 + 4 = 6, or 4 + 8 = C)

6.4 Calibration Errors

Error	Description	Resolution
(FAILED) (BAND)	An attempt has been made to calibrate with a weight or signal which is not in the valid range.	Check weights and retry.
(FAILED) (ERROR)	An attempt has been made to calibrate while the scale signal is not valid.	Check loadcell connection and the 4-wire/6-wire setting.
(FAILED) (TIMEOUT)	For an unknown reason, the calibration was unable to complete.	Retry.
(FAILED) (RES)	An attempt has been made to calibrate the scale to a resolution which is too high for the instrument.	Check weights and retry.
(FAILED) (TOO CLOSE)	An attempt has been made to add a linearisation point too close to zero, span or another linearisation point.	Check weights and retry.