

# SMART WEIGHING SOLUTIONS



## C3 Series Digital Indicators Reference Manual

## **Copyright**

All Rights Reserved. No part of this document may be copied, reproduced, republished, uploaded, posted, transmitted, distributed, stored in or introduced into a retrieval system in any form, or by any means (electronic, mechanical, photocopying, recording or otherwise) whatsoever without prior written permission of Rinstrum Pty Ltd.

## **Disclaimer**

Rinstrum Pty Ltd reserves the right to make changes to the products contained in this manual in order to improve design, performance or reliability. The information in this manual is believed to be accurate in all respects at the time of publication, but is subject to change without notice. Rinstrum Pty Ltd assumes no responsibility for any errors or omissions and disclaims responsibility for any consequences resulting from the use of the information provided herein.

---

## Contents

1	Introduction	1
2	Installation	2
2.1	General Warnings	2
2.2	Environmental Conditions	2
2.3	Electrical Safety	3
2.4	Cleaning	3
2.5	Mounting	3
2.6	Power Connections	4
2.7	Loadcell Connection	4
2.8	Other Connections (Serial, Digital Inputs and Outputs)	6
2.9	Optical Communications	9
2.10	Connecting Shields	9
2.11	Accessory Card connection	10
3	Basic Operation	11
3.1	User Interface	11
3.2	Display	12
3.3	Has a key been locked?	12
3.4	Stability – What is a “Error Motion”?	13
3.5	Power Key	13
3.6	Zero Key	13
3.7	Tare Key	14
3.8	Select Key	15
3.9	Unit Key	15
3.10	Function 1 & 2 Keys	16
4	Data Entry	17
4.1	Accessing Setup Menus	17
4.2	Exiting Setup Menus	18
4.3	Navigation	19
4.4	Editing Option Items	20
4.5	Editing Weight and Number Items	21
4.6	Editing With Functions	21
5	Setup Menus	22
5.1	General Options	22
5.2	Scale	25
5.3	Serial	32
5.4	Set Points	35

---

5.5	App .....	37
5.6	Test .....	42
5.7	End .....	42
6	Configuration .....	43
6.1	General Setup Information .....	43
6.2	Correct Loadcell Selection .....	43
6.3	Filtering Techniques .....	44
6.4	Industrial vs Trade Modes .....	44
6.5	Calibration Counter .....	45
6.6	Passcodes (GEN.OPT:PCODE) .....	45
7	Calibration (SCALE:CAL) .....	46
7.1	Performing a Digital Calibration with Test Weights .....	46
7.2	Performing a Calibration with Direct mV/V Entry .....	47
7.3	Using Linearisation (ED.LIN) .....	48
7.4	Using Gravity Compensation (GRAVITY) .....	49
8	Special Functions (FUNC) .....	50
8.1	NONE .....	50
8.2	TEST .....	50
8.3	HOLD .....	50
8.4	PEAK HOLD .....	50
8.5	SINGLE .....	51
8.6	Remote Key or Blanking Input .....	51
8.7	HI.RES .....	51
8.8	TOTAL .....	51
8.9	PRINT .....	52
8.10	TARGET .....	54
8.11	UNITS .....	55
8.12	LIVE .....	55
9	Serial Outputs (SERIAL) .....	57
9.1	Network rinCMD (RINCMD) .....	57
9.2	Network Protocol SIMPLE (SIMPLE) .....	61
9.3	Network REMOTE (REMOTE) .....	62
9.4	Automatic Weight Output (SER.AUT) .....	63
9.5	Printing (PRINT) .....	64
10	Setpoints (SETP) .....	67
10.1	Common Settings .....	67
10.2	Weigh in (OVER) Setpoints and Weigh Out (UNDER) Setpoints .....	68

---

---

10.3 OVER Setpoint Timing Options .....	69
10.4 Status based Setpoint Types .....	69
11 Licensing .....	71
11.1 Unlicensed Software .....	71
11.2 Licence Code Entry from Keypad .....	71
12 Upgrading Firmware .....	72
12.1 Upgrade using flash programming executable .....	72
12.2 Upgrade in boot mode .....	74
13 Print and Automatic Transmission Tokens .....	76
13.1 ASCII codes .....	76
13.2 Use of Characters in the Extended ASCII table .....	77
13.3 Tokens .....	77
14 Appendix - Dimensions .....	83
15 Appendix - Error Messages .....	87
15.1 Weighing Errors .....	87
15.2 Setup Errors .....	87
15.3 Diagnostic Errors .....	88
15.4 Calibration Errors .....	89

## 1. INTRODUCTION

The C320, C350 and C357 are C3 series precision digital indicators. C3 series indicators use a sigma-delta analog-to-digital (A/D) converter to ensure extremely fast and accurate weight readings. This advanced technology allows the C3 series indicators to be configured for up to 100,000 divisions at 60 A/D conversions per second. The units have extended sensitivity adjustment which can handle scales with outputs 0.2-5.0mV/V for full range. The design is optimized to deliver precision performance on scale bases delivering above 0.5mV/V at display resolutions of up to 10000 divisions.

The C3 series digital weight indicators have a RGB LCD with 6 digits, 9 segments with units indicators and annunciators. The instrument has 8 setpoints which can be set to display using main display colors. The setup and calibration are digital, with a non-volatile security store for all setup parameters. The built-in clock can be used to date-stamp printouts. There is an FRAM store to ensure day to day operating settings (zero, tare, date/time, etc) are retained when power is removed.

The instrument is fitted with rinLINK communications as standard. This allows a temporary isolated communications link to be established with a PC using an rinLINK cable, which enables software upgrades and the use of computerised setup and calibration via the Viewer software.

The C3 series includes the following interfaces:

- 2 x Bi-directional RS232 ports
- 1 x Accessory port for connecting communication cards or expansion cards
- 2 x isolated high side switched digital outputs capable of driving 400 mA
- 2 x isolated digital inputs (5-24 V)

Optional accessory modules can be connected using the Accessory port to add more functionality to the digital weight indicator.

- Communication cards
  - C3 Series RS232 Communications card - M6201
  - C3 Series RS485 Communications card - M6203
  - C3 Series 20 mA Current Loop Communications card - M6204
- Expansion Cards
  - C3 Analogue Expansion card - M6401
  - C3 Series WIFI/ Bluetooth Communications card - M6223

## 2. INSTALLATION

The following steps are required to set up the indicator.

- Inspect indicator to ensure good condition.
- Use connection diagrams to wire up load cell, power and auxiliary cables as required.
- Insert any accessory modules that are being used.
- Use the drill hole template provided for hole locations.
- Connect Power to indicator and press <power> key to turn the instrument On.
- Refer to the Configuration  for information on configuring the instrument.
- To turn instrument OFF press and hold key for three seconds (until display blanks).

### 2.1 General Warnings

The C320 unit is available in panel mount and can be fitted with a range of boots or desk stands for desk, wall or post mounting. The C350 and C357 are full housing indicators where the stainless steel stand serves for desk, wall or post mounting. It contains precision electronics and must not be subject to shock, excessive vibration, or extremes of temperature, either before or after installation. The operating environment must fall within the allowed temperature range and humidity.

The inputs of the C320, C350 and C357 are protected against electrical interference, but excessive levels of electromagnetic radiation and RFI may affect the accuracy and stability of the instrument. The C320, C350 and C357 should be installed away from any sources of electrical noise. The loadcell cable is particularly sensitive to electrical noise, and should be located well away from any power or switching circuits. Termination of the loadcell shield at the indicator end (with a sound connection to the indicator case via the screw terminal shield connection) is important to reduce these possible effects.

The C320, C350 and C357 units must be installed away in a manner and location that is protected from impacts.

**Warning! If the equipment is not installed and used as specified by the manufacturer, the protection provided by the equipment may be impaired.**

### 2.2 Environmental Conditions

The C320, C350 and C357 indicators designed for use in the following environmental conditions:

- C320: Indoor use only. Although the front of the device can be washed down (as per IP65), the rear of the device, along with cable attachments and optional accessories, must be protected from liquids and small objects (as per IP30).
- C350:Stainless steel enclosure and C357:Resin alloy enclosure: Indoor use only : Rated to IP65
- Operating temperature range: -10 °C to 40 °C
- Storage temperature range: -20 °C to 50 °C
- C320: DC power supply (5-24 VDC)
- C350 and C357: AC (110-240VAC 50/60Hz) or DC (5-24 VDC) power supply

## 2.3 Electrical Safety

For protection all mains electrical hardware must be rated for environmental conditions of use. Pluggable equipment must be installed near an easily accessible power socket outlet. To avoid the possibility of electric shock or damage to the instrument, always switch off or isolate the instrument from the power supply before maintenance is carried out.

## 2.4 Cleaning

To maintain the instrument, never use harsh abrasive cleaners or solvents. Wipe the instrument with a soft cloth slightly dampened with warm soapy water.

## 2.5 Mounting

The C320 is a compact panel mount indicator which can be used with rear housing to use as a desk mount indicator.

M6001	Black desk mount housing with non-slip rubber feet for desktop use. This can hold 4 x AA batteries and includes external 2.1mm power input socket for DC plug pack.	
M6003	Water proof (IP65) black desk mount housing supplied together with 2 x PG7 glands.	
M3002	Stainless steel swivel bracket ( 39mm high) for wall mounting	
M3007	Stainless steel bracket for pole mounting	
M3014	Stainless steel swivel bracket ( 64mm high) for wall mounting	
M3021	Stainless steel mounting bracket for scale base	

The panel mount template is supplied with the instrument. It shows the location of the rectangular cut-out and the four mounting screws.



## 2.6 Power Connections

The C320 can be powered from a DC power supply (5-24 VDC). The C350/ C357 has two variants each that can be powered by either AC (110/240 VAC 50/60Hz) or DC (5-24 VDC). The supply need not be regulated, provided that it is free of excessive electrical noise and sudden transients. The C3 series can operate from good quality plug-packs of sufficient capacity to drive both the indicator and the load cells.

The case ground connection is available via the screw terminal on the rear of the unit. The resistance measured between the case of the indicator and the nearest earth point should be less than 2 ohms.

## 2.7 Loadcell Connection

The C3 series can drive any number of full bridge strain gauge loadcells up to the equivalent of 8 x 350 ohm cells.

The span range of the loadcell outputs (the change of signal from the loadcells between zero load and full gross load) must be within the range of 0.1 to 3.0 mV/V. Very low output scale bases can be used with the C3 series, but may induce some instability in the weight readings when used with higher resolutions. Generally speaking, the higher the output, or the lower the number of divisions, the greater the display stability and accuracy.

When shunting loadcells, use only good quality metal film resistors with high temperature stability ratings. Typical values for zero adjustment would fall within the range of 500k ohms (small effect) to 50k ohms (larger effect).

The C3 series has a mV/V meter test mode which can be used to check scale base signal output levels. Refer to mV/V test mode [42](#).

### 2.7.1 Cable

When wiring loadcells use only high quality shielded multi-core cable. The cable should be run as far away from any other cabling as possible (minimum separation distance 150mm). Do not bundle loadcell cables with power or control switching cables as interference can trigger display instability, and cause unreliable operation.

The loadcell shield must be installed so as to connect electrically with screw terminal shield connection in order for the C3 series to provide its full EMC resistance. Any noise absorbed by the cable shield must be conducted as quickly as possible to the indicator case via screw terminal shield connection, then direct to a solid earthing point via earthing lug.

### 2.7.2 6-Wire Connection

The loadcell socket is wired for six wire systems as follows:

Screw Terminal Pin	Function
1	Positive excitation
2	Negative excitation
3	Positive signal
4	Negative signal
5	Positive sense
7	Negative sense
8	Shield

Loadcell wires are connected as shown in below diagram.

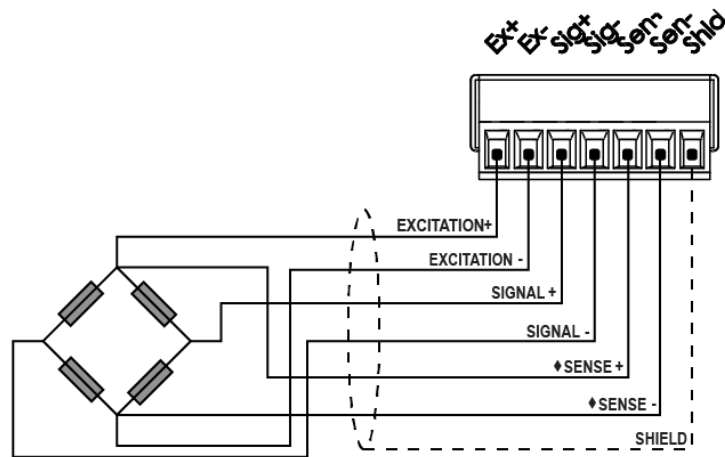

Figure 1: 6-Wire Connection

### 2.7.3 4-Wire Connection

The minimum connectivity requirements for loadcell connection are the connection of four wires (i.e.  $\pm$ Excitation and  $\pm$ Signal). When a four wire loadcell system is connected, it is necessary to ensure that the excitation voltages are fed into the sense inputs using jumper wires as shown in below diagram.

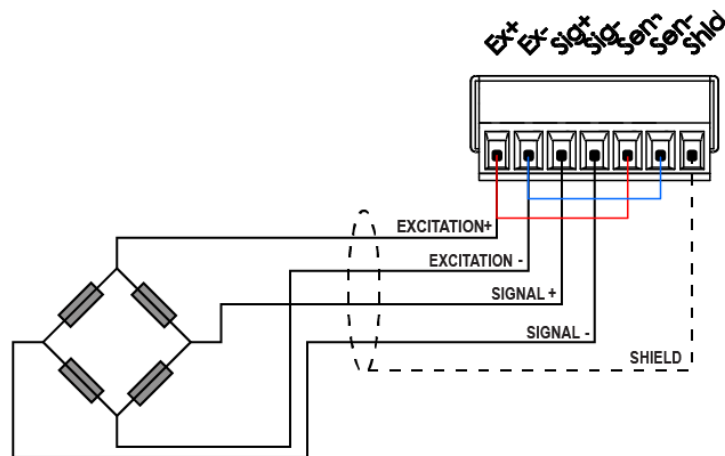

Figure 2: 4-Wire Connection

Any addition to the load cell manufacturer's cable length using 4-wire connection is only recommended for short cable runs. Where long additions to cable lengths are needed, a 6-wire extension is required.

**Warning! Sense lines must be connected or 4/6 wire jumpers fitted as shown in dashed lines in above figure. Failure to do this will result in the C3 series displaying an error message (E00040, E00080 or E000C0).**

## 2.8 Other Connections (Serial, Digital Inputs and Outputs)

The C3 supports the following connections:

- 2 x serial ports (2 bi-directional RS232)
- 2 x isolated digital inputs
- 2 x isolated high side switched digital outputs
- 1 x regulated 5 V output for driving small loads (below 0.5 A)

### 2.8.1 Serial Port 1 & 2 Connections

C3 series indicators have two RS232 (bi-directional) ports. The RS232 drivers are generally used for connecting external computers or PLCs. The connections are shown below.

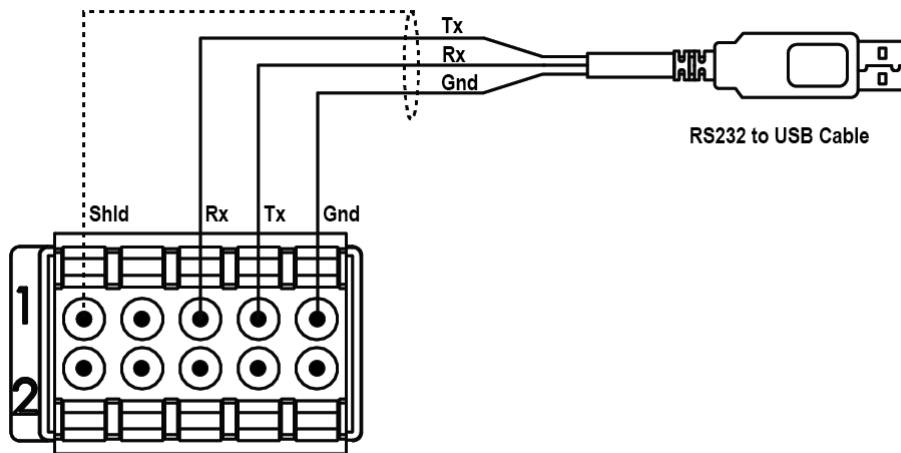

Figure 3: RS232 to USB Connection

Pin Number	Function	Direction	Connect to external device
1	Shld	Shield	Connect to cable shield
2 *	5V	5V output	Power for printer or converter (300mA max)
3	TX	RS232 transmit	Receive (Rx pin of the converter)
4	RX	RS232 receive	Transmit (Tx pin of the converter)
5	Gnd	RS232 ground	Ground

**Warning! Pin number 2: 5 V Power output is not an input. Do not attempt to power the indicator by connecting 5V DC source to this pin.**

## Ring Networks

C320, C350 and C357 can be configured in a Ring Network to connect multiple indicators to a external computer or PLC. The connections are shown below.

When operating in a Ring Network, the Instruments:

- must have same serial port options, i.e., baud, parity, data bits, stop bits.
- recommended that all indicators use the same power supply.

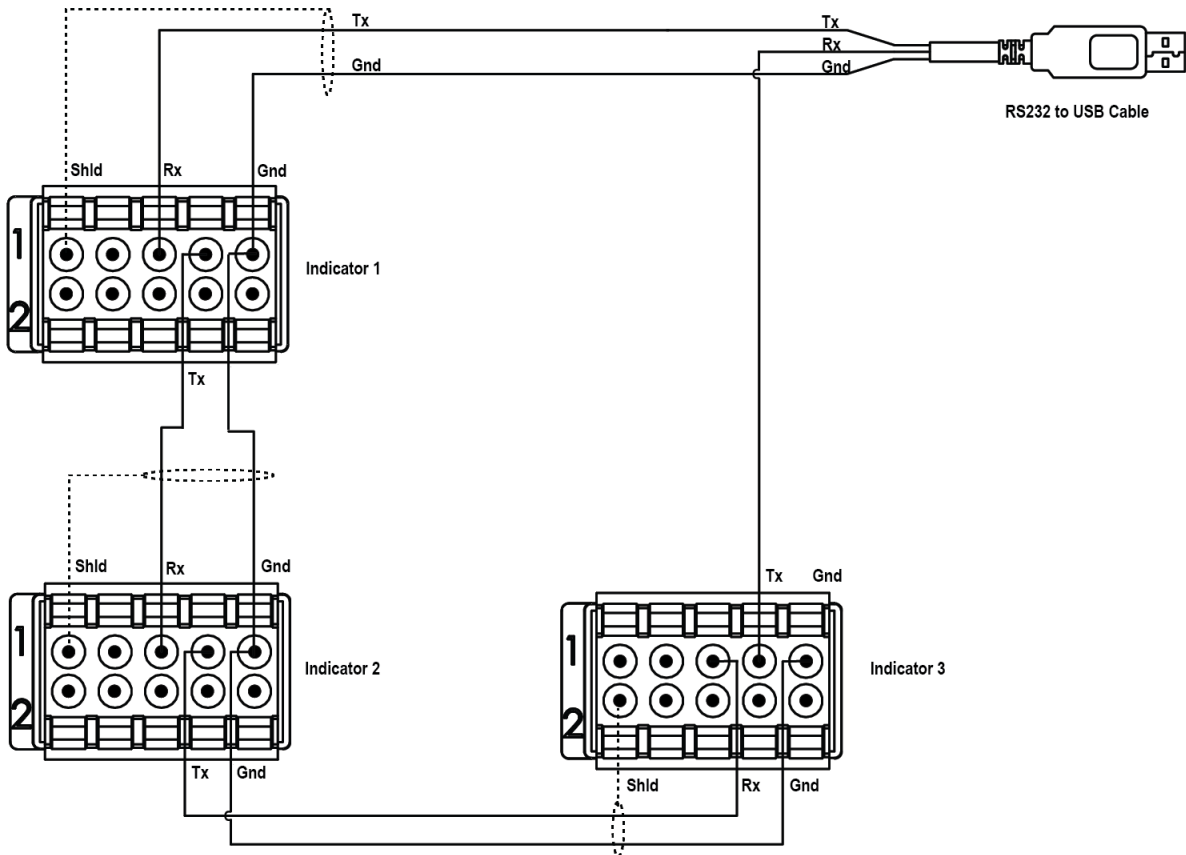

Figure 4: Ring Network Connections

## Remote Display

The remote display documentation should be referred for connection details. Connect Tx to Rx, Rx to Tx and GND on the remote display as shown in the diagram.

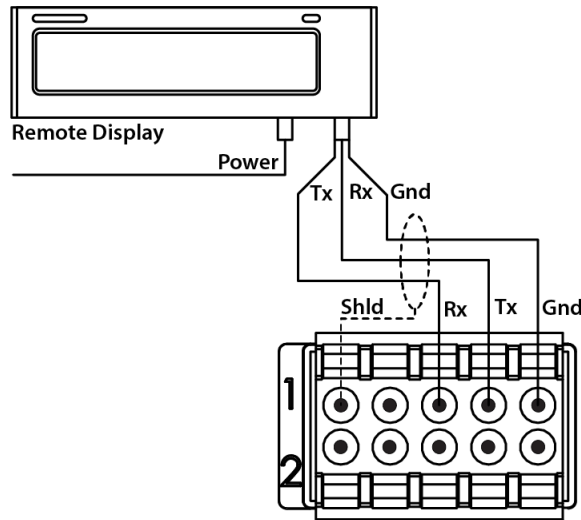

Figure 5: Remote display Connection

### 2.8.2 Digital Input and Output Connection

The C3 series isolated digital inputs should be connected as shown in the diagram below.

The digital outputs are isolated high side drivers. They should be connected as indicated in the diagram below.

The power supply for the outputs should be 5 - 24 Vdc, with sufficient current capacity to drive the solenoids. Each digital output has a drive capacity of up to 400 mA. Cable shields should be connected to the indicator shield pins as shown.

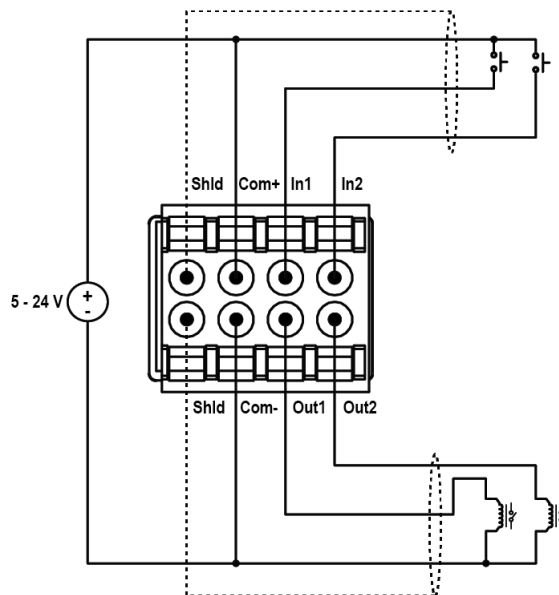

Figure 6: Input and Output Connections

## 2.9 Optical Communications

A temporary infrared communications link can be established between the instrument and a PC using an rinLINK attachment. This connection can be used to transfer setup and calibration information from a PC.

The PC end of the cable is a standard USB connector. The instrument end of the cable attaches to the left side of the indicator display as shown below.



Figure 7: rinLINK connection

**Warning! The optical coupling head contains a strong magnet and should not be placed near any magnetic storage media (eg. credit cards, floppy disks etc.)**

## 2.10 Connecting Shields

To obtain full EMC or for RFI immunity, cable shields **MUST** be connected and the earth lug on the rear of the instrument must be grounded. Below image illustrate possible connections.

### Cable Shield Connection and Earthing

- Care should be taken when connecting shields to maximise EMC or RFI immunity and minimise earth loops and cross-talk (interference) between instruments.
- For full EMC or for RFI immunity, termination of the cable shields to the connectors is very important. The earth pin of the instrument must be separately connected to ground potential via a reliable link.
- The instrument should only be connected to earth via a single reliable link to avoid earth loops.
- Where each instrument is separately earthed, interconnecting cable shields should be connected at one end only. This also applies to communications cable shields in Ring Networks, refer Ring Networks [\[7\]](#).
- Caution: Some load cells connect the cable shield directly to the load cell (and therefore the scale base). Connection of the load cell cable shield in this situation may be site specific.

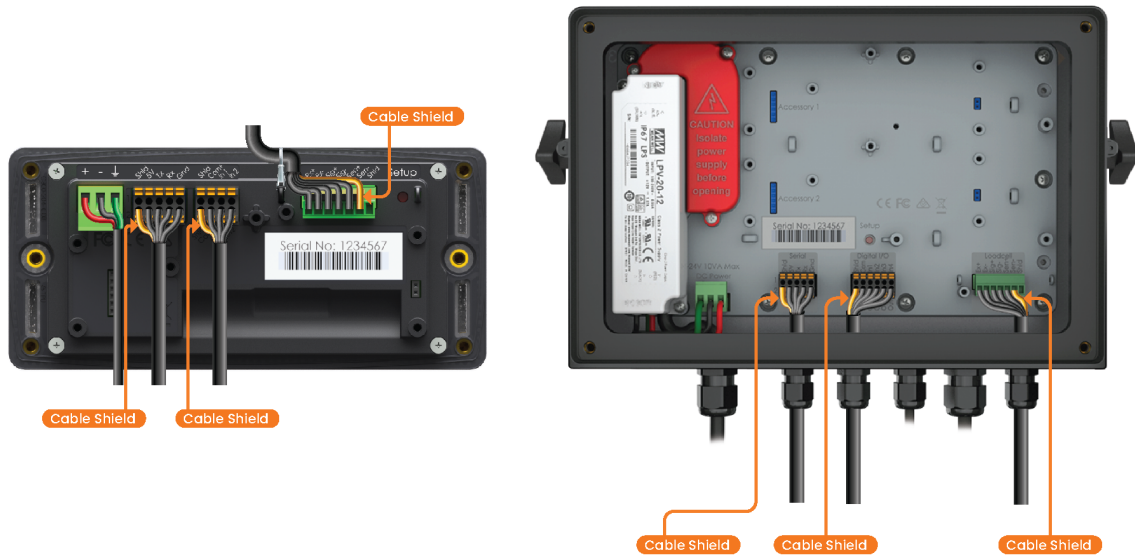

Figure 8: Shields Connection

## 2.11 Accessory Card connection

Optional accessory modules can be connected using the Accessory port to add more functionality to the digital weight indicator. There are two types of accessory cards available.

- Communication cards
- Expansion Cards

These are connected to rear of the indicator using the accessory port.

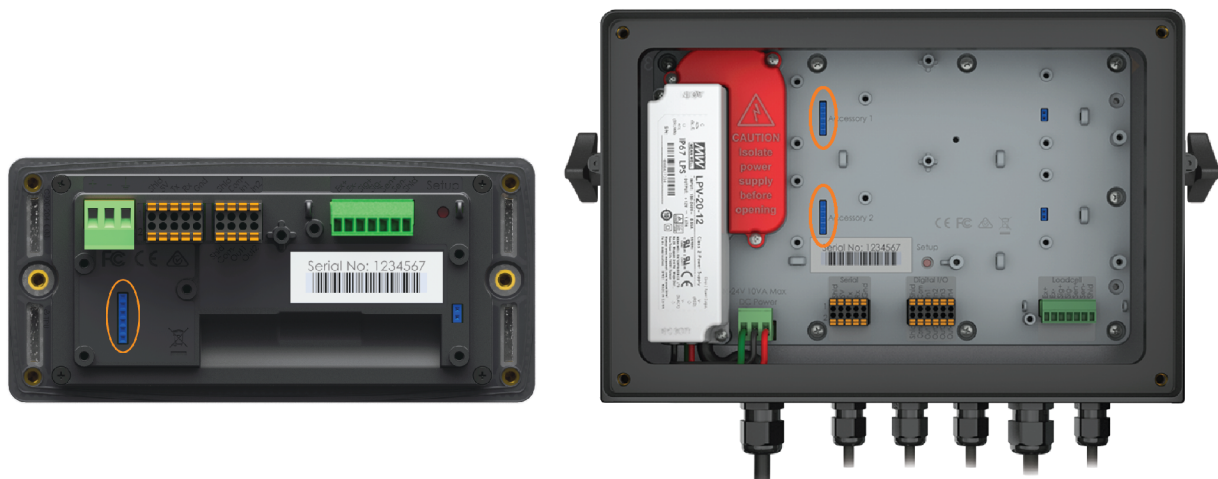

Figure 9: Accessory Card Connection

### 3. BASIC OPERATION

The C3 series has a six digit RGB LCD display and a 7 key keypad. The 7 front panel keys that control the operation of the instrument. The 8th key (SETUP) is on the rear of the instrument. The setup key can be sealed to prevent unauthorized tampering of trade critical settings and calibration. Each of the front panel keys has two separate functions:

- A normal function that is available during normal weighing (as printed on the key). These are described below.
- A setup function which is available during setup and calibration (as printed beneath the key).

#### 3.1 User Interface

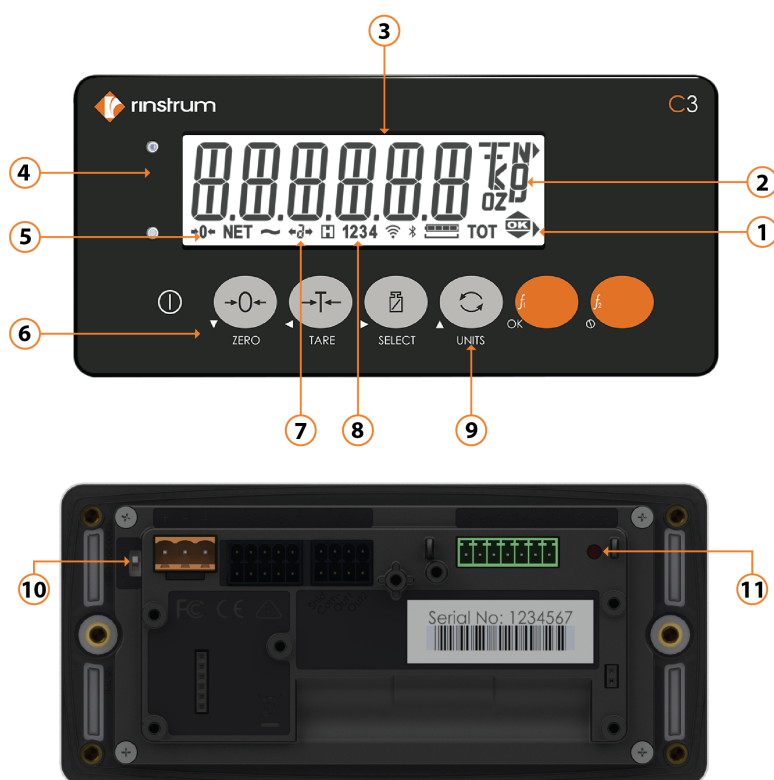

Figure 10: Front and Back of the Indicator







The C3 user interface includes:

- |   |                                   |
|---|-----------------------------------|
| 1. Check weigh status                     | 7. Multiple range/interval status |
| 2. Units indicator                        | 8. Output status                  |
| 3. Six digit nine segment RGB LCD display | 9. Units Key                      |
| 4. rinLINK attachment                     | 10. Power Override Switch         |
| 5. Weighing status                        | 11. Full setup key                |
| 6. Seven key keypad                       |                                   |

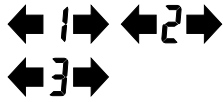

### 3.2 Display

- Display (3): weight readings, errors, information and setup.
- Units indicator (2): units for the weight reading (kilograms (kg), pounds (lb), tonnes (t), and tons (TN), grams (g), ounces (oz), Newton (N) and Kilonewton (kN).
- Status indicators (1), (5), (7) and (8): The weighing status (5) shows the status of the displayed reading. The multirange status (7) shows the current multirange operation. The setpoint status set (8) shows the status of the 2 switch inputs and 2 digital outputs (IO).

	Lit when the displayed reading is within $\pm \frac{1}{4}$ of a division of true zero.
	Lit when the displayed reading is in motion.
<b>NET</b>	Lit when the displayed reading represents net weight.
	Lit when the displayed reading is within the zero band.
	Lit when the display reading has been held.
	Ranges 1, 2 and 3 (multiple range/interval modes only)
<b>1 2 3 4</b>	1 and 2 lit to indicate when the outputs are active.
	Lit to indicate various states during checkweigh.
<b>TOT</b>	Lit to indicate that the displayed weight is a total
	Lit when operating on battery, to indicate the charge level of the battery

### 3.3 Has a key been locked?

A single press of each key triggers the weighing operation printed on it. The instrument allows individual keys to be disabled in the setup. All keys are enabled at the factory, but some keys may have been intentionally disabled (locked) during installation. If a key has been locked, a long beep sounds when it is pressed. If however, the key beeps normally, but does not appear to trigger the desired action, it may be waiting for the weight reading to settle before the action can proceed.

### 3.4 Stability – What is a “Error Motion”?

Once a <ZERO>, <TARE> or <PRINT> key is pressed the instrument waits for a stable valid reading before performing the associated operation. If the weight readings remain unstable or invalid due to some diagnostic error for longer than 10 seconds, the operation is cancelled and the ERROR MOTION message is displayed.

To improve the stability of the weight reading, increase the filtering or relax the motion detection criteria. {Refer to FILTER<sup>[28]</sup> (Reading Average) and MOTION<sup>[28]</sup> (Motion Detection) for more information.}

### 3.5 Power Key

Power Key		
Normal function	Power	<p>The &lt;POWER&gt; key is used to turn the instrument on and off.</p> <p>To initially turn the instrument on, press the &lt;POWER&gt; key.</p> <p>The display will show the following:</p> <ul style="list-style-type: none"> <li>• Display segments will light and then clear.</li> <li>• Software Version (e.g. V4.0).</li> <li>• Calibration Counter (e.g. C.00010). Refer to Calibration Counter<sup>[45]</sup> for more information.</li> <li>• Configuration Counter (e.g. F.00015).</li> <li>• The current weight will then display.</li> </ul> <p>To turn the instrument off, press and hold the &lt;POWER&gt; key for three seconds. The instrument will display OFF followed by the 3s countdown.</p> <p>Locking: The key can be locked to prevent the instrument being turned off from the front keypad using KEY.LOC (Front Panel Key Locking)<sup>[23]</sup> in General option Settings or using the power override switch in the back of the indicator.</p>
Long press function	Turn off	Display the power off countdown, then turn off.
Automatic Operation		The key has a memory function associated with it. This means that the power state is remembered even if external power is interrupted. It is therefore possible to turn the instrument on in the safe knowledge that it will operate whenever external power is available and will not need to be manually turned on again if the power is interrupted.

### 3.6 Zero Key

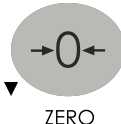
Zero Key	
----------	---

Normal function	Zero	<p>When an empty scale has drifted away from a true zero reading, this &lt;ZERO&gt; key is used to perform a zero adjustment on the scale display. The zero adjustment is stored when power is removed and is re-used when next powered up.</p> <p>The amount of weight that may be canceled by the &lt;ZERO&gt; key is limited via an item in the Setup of the instrument. Refer to Z.RANGE (Allowable Zero Operating Range) [29] for more information.</p> <p>Locking: The key can be locked to prevent the normal function is being performed from the front keypad. Refer to KEY.LOC (Front Panel Key Locking) [22] for more information.</p>
Long press function		

### 3.7 Tare Key

Tare Key		
Normal function	Tare	<p>This key is used to temporarily set the scale to zero (such as canceling the weight of a carton before performing a filling operation). The display will show the Net weight and the NET annunciator will be lit.</p> <p>The weight tared is deducted from the allowable range of the scale, reducing the maximum weight that can be displayed.</p> <p>Locking: The key can be locked to prevent the normal function is being performed from the front keypad. Refer to KEY.LOC (Front Panel Key Locking) [22] for more information.</p> <p>If PT.CLR [30] is OFF then it is possible to first set a PRESET TARE on the device and then set a separate TARE that operates along with the PRESET TARE. <math>NET = GROSS - PT - TARE</math>. There is a new weight source called NET.PT which is equal to <math>GROSS - PT</math>. When printing it is necessary to print GROSS, PRESET TARE, TARE and NET when using this mode. It is not possible to change the PRESET TARE value if there is an active TARE value set on the instrument.</p> <p>Both TARE and PRESET TARE are cleared when ZERO is pressed.</p> <p>The key application for this is filling/discharging vessels where there is a known TARE weight of the empty vessel that is entered and the NET.PT value is then the amount of material remaining in the vessel. In order to add/remove material from the vessel it is tared and the net change can be displayed. Instead of going back to GROSS though when TARE cleared we can go back to NET.PT as an indication of material available in the vessel.</p>

Long Press		<p>This feature allows the operator to manually enter the tare weight. After setting the preset tare value, indicator will display Pt followed by selected preset tare value. When a preset tare weight is being used the instrument will display Pt before displaying the net weight.</p> <p>A long press of the &lt;TARE&gt; key will allow editing of the Preset Tare value. Press the &lt;OK&gt; key to enter the Preset Tare setting. Change the Preset Tare setting using the &lt;ARROWS&gt; keys.</p>
		<p>The Preset Tare setting can be cleared by one of three means:</p> <ul style="list-style-type: none"> <li>• Using a long press of the &lt;TARE&gt; key and editing the preset tare value to zero.</li> <li>• While the gross load is zero; Using a short press of the &lt;TARE&gt; key to re-tare the instrument in the usual manner.</li> <li>• OR, Using a short press of the &lt;ZERO&gt; key to zero the instrument in the usual manner.</li> </ul>

### 3.8 Select Key

Select Key	 SELECT	
Normal function	Gross / Net	<p>This key is used to toggle the weight display between the Gross weight and the Net weight (provided that a Tare has previously been acquired using the &lt;TARE&gt; key).</p> <p>Locking: The key can be locked to prevent the normal function from being performed from the front keypad. Refer to KEY.LOC (Front Panel Key Locking) <sup>23</sup>.</p>
Long Press	Setup Menus	This will allow to access the Setup Menus <sup>17</sup> .

### 3.9 Unit Key

Unit Key	 UNITS	
Normal function	Change units	<p>The units key is used to convert primary (calibrated) unit to alternative units (2 secondary units available). The short press will step through and display up to three units as per setup.</p> <p>Locking: The key can be locked to prevent the normal function from being performed from the front keypad. Refer to KEY.LOC (Front Panel Key Locking) <sup>23</sup> for more information.</p>

Long Press	Piece count	When piece counting is enabled (using P.COUNT setting) pieces (p) is one of the available units and the long press varies. When there is no piece counting, a long press has no function. Refer UNITS <sup>[55]</sup> Section for more information.
------------	-------------	---

### 3.10 Function 1 & 2 Keys

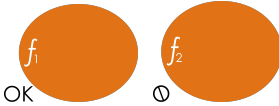
Function Keys		
Normal function	Configurable	<p>The function of this key can be selected from a number of distinct functions including totalisation, unit switchin, etc. Refer to Special Functions (FUNC)<sup>[50]</sup> page for details of the available functions.</p> <p>Locking: The key can be locked to prevent the normal function is being performed from the front keypad. Refer to KEY.LOC (Front Panel Key Locking)<sup>[23]</sup> for more information.</p>
Long Press		A long press of the key may be used for certain functions depending on the primary function of the key.

## 4. DATA ENTRY

Throughout the setup menus different data entry methods are used. Each method is described below.

### 4.1 Accessing Setup Menus

There are two methods to access the Setup Menu areas.

1. Press and hold the <SELECT> keys for two seconds.
2. Press the setup button on the rear of the instrument.

When accessing the Menu area, the instrument will beep twice and back light will turn blue throughout the Menu area and Setup Menus.

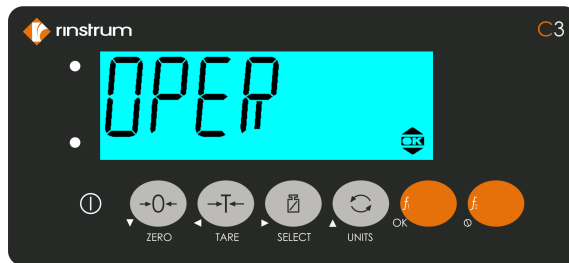

Figure 11: Menu area

Menu area has following Menu option to access various settings of the indicator. Navigation through the Menu area using <SELECT> to step through the options.

OPER	Operator Menu	Operator Menu provide access to some settings typically used by operators.
ALIBI	Alibi Application	The Alibi application is part of the trade approval and makes it possible to verify scale readings or view DSD log entries.
CAL	Calibration Menu	Items in this group are used for scale calibration. See Section Calibration (SCALE:CAL) <sup>46</sup> .
FULL	Full Setup Menu	Full Setup Menu provides access to all functions in Setup, including legal for trade and calibration sensitive settings. Changes in Full Setup mode may result in the calibration counter being incremented. If an attempt is made to enter Full Setup using the incorrect passcode, the instrument will respond with the message ENTRY DENIED. Refer to Passcodes (GEN.OPT:PCODE) <sup>45</sup> for more information.

SAFE	Safe Setup Menu	Safe Setup restricts access to the Trade Critical settings. Changes made in this mode will not increment the calibration counter. In this manual, items marked with indicate that the setting is trade critical. If an attempt is made to enter Safe Setup using the incorrect passcode, or if an attempt is made to alter a trade critical setting while in Safe Setup, the instrument will respond with the message ENTRY DENIED. Refer to Passcodes (GEN.OPT:PCODE) <sup>[45]</sup> for more information.
------	-----------------	--

Once selected, press OK to enter the Menu. Enter the passcode if a passcode has been set: Use the ▲▼◀▶ to enter the passcode. Press the <OK> key to confirm the passcode.

To Exit the Setup Menu area press  key.

**Note 1: Full setup will not be available if this has been disabled in the setup.**

**Note 2: Access to Full setup from front keys will be denied if R.ENTRY is enabled. This options is available only if setup menu is accessed from rear setup button. Refer SCALE:OPTION:R.ENTRY<sup>[30]</sup> for more information.**

### Setup Display Prompts

When accessing Full Setup, Safe Setup or the Operator Setup, the instrument will beep twice and back light will turn blue throughout the Setup Menus. If a passcode has been configured, the P.CODE prompt will display and the correct passcode must be entered to continue. Refer to Passcodes (GEN.OPT:PCODE)<sup>[45]</sup> for more information.

If access is granted the following is displayed:

Software → Software Version (eg. V1.0) → Calibration Counter (eg. C.00010) → Configuration Counter (eg. F.00015).

(See Calibration Counter<sup>[45]</sup> page or more information)

## 4.2 Exiting Setup Menus

To save settings, exit setup and return to the normal weighing mode use one of the following methods:

Method 1: Press and hold both the <POWER> and <SELECT> keys together for two seconds.

Method 2: Press the <ZERO> key repeatedly. When End displays press <OK> key.

When exiting the following is displayed:

Software → Software Version (eg. V1.0) → Calibration Counter (eg. C.00010) → Configuration Counter (eg. F.00015).

### 4.3 Navigation

The setup menus are organized in a tree structure. With multiple layers of sub menus. Each layer is traverse with it's own key.

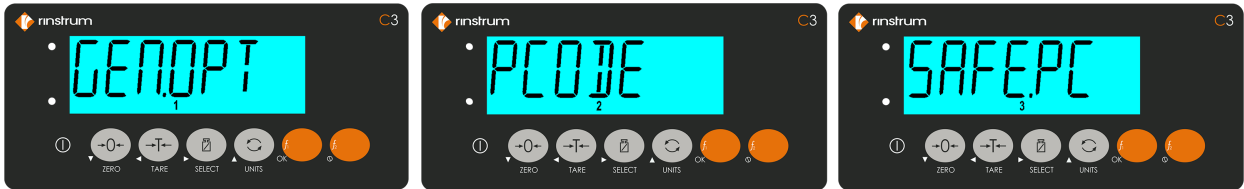

Figure 12: Menu Levels

The numbers 1...4 are displayed to show which layer is currently active. Navigating through each layer is assigned to keys Left to right starting at <ZERO> Key as shown in the below table.

#### ZERO Key

 ZERO	Setup Menu function	1	Step through the list of top level menu items.
	Setup editor function	▼	Decrement selected digit in number editor. Previous option in bit and list editor.

#### TARE Key

 TARE	Setup Menu function	2	Step through the list of second level menu items.
	Setup editor function	◀	Navigate left when editing numbers, string and bit editors.

#### SELECT Key

 SELECT	Setup Menu function	3	Step through the list of third level menu items.
	Setup editor function	▶	Navigate right when editing numbers, string and bit editors.

#### Unit Key

 UNITS	Setup Menu function	4	Step through the list of fourth level menu items.
	Setup editor function	▲	Increment selected digit in number editor. Previous option in bit and list editor.



**F1 Key**

	Setup Menu function	OK	Descend to the next level down of menus or start editing the current menu item.
	Setup editor function	OK	Accept the current change.

**F2 Key**

	Setup Menu function	Back	Step back through items at the current level.
	Setup editor function	⊖	Cancel the current changes.

**Setup Key**

	Setup Menu function	Save and exit setup	Save changes and exit setup.
	Setup editor function	Save and exit setup	Exit current editor, save changes and exit setup.

**4.4 Editing Option Items**

Some settings allow the choice of an option from a predefined list of options. Below Icon will be shown in the display to indicate the keys to be used.

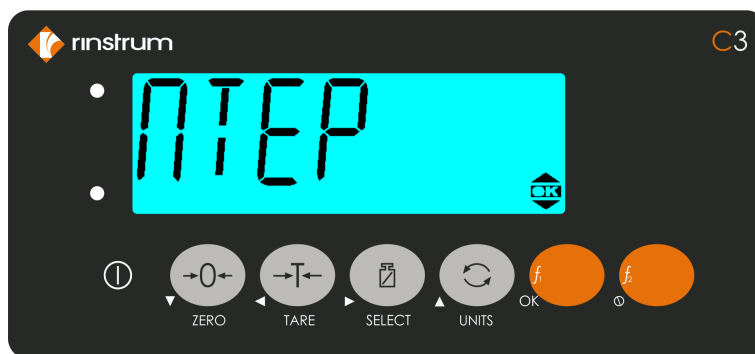

Figure 13: Editing Option Items

Examples are BUILD:DP or OPTION:USE. To show/edit:

- Press the OK key to show the current setting
- Press the ▲ or ▼ keys until the correct setting is shown
- Press the OK key to exit the editor

## 4.5 Editing Weight and Number Items

Some settings require the entry of a weight or other number. Examples are BUILD:CAP1 or OPTION:Z.BAND. The correct decimal point and units (if applicable) are shown while editing.

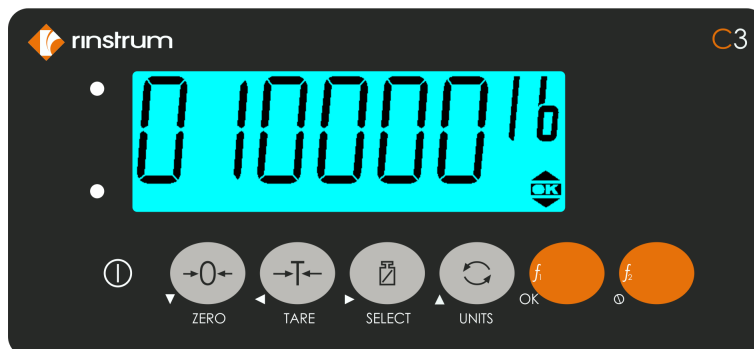

Figure 14: Editing Weight and Number Items

To show/edit:

- Press the OK key to show the current setting
- Use the ◀▶ keys (change digit) and the ▲▼ keys (increment/decrement digit) to show the correct value Press the OK key to exit the editor

If the setting is not possible (for example if the value is greater than the allowed maximum), ----- is shown and the editor will not exit.

## 4.6 Editing With Functions

Some settings have a special function to control their use. These are not simple settings but are more complex routines. Examples are CAL:ZERO or TEST:SCALE. To use:

- Press the OK key to start the function
- All functions are different and there are no standard keys. The user will be prompted for what is required.
- Use the cancel key to exit the function

## 5. SETUP MENUS

### 5.1 General Options

GEN.OPT	General Options		
L2	L3	Short Description	Long Description
PCODE	Passcode		Sets the instrument Passcodes. There are three levels of Passcode.
	SAFE.PC	Safe Security Passcode for Digital Setup	Allows partial access to Digital Setup (i.e. only non-calibration/trade critical settings can be changed). For the Safe Passcode to have any effect, the FULL.PC Passcode must also be set. The default Passcode setting is 000000 that allows free access. Any other number will enable the Passcode functions and restrict access. The safe Passcode will also give access to operator functions. <ul style="list-style-type: none"> <li>• Range 000000 (Default) to 999999</li> </ul>
	FULL.PC	Full Security Passcode for Digital Setup	All settings (including trade critical settings) can be altered from Full Setup. The FULL.PC (Full Passcode) can be set to restrict access to Full Digital Setup. This Passcode is used to prevent unauthorised or accidental tampering in the instrument setup. The default Passcode setting is 000000 that allows free access. Any other number will enable the Passcode functions and restrict access. The full Passcode will also give access to Safe or Operator functions. <ul style="list-style-type: none"> <li>• Range 000000 (Default) to 999999</li> </ul> <p>It is important to note that when restricting full access to setup the Passcode must not be forgotten. It is only possible to circumvent the Passcode at the factory. Care must be taken when setting the Full Digital Setup Passcode to ensure that the instrument does not become permanently locked.</p>
	OP.PC	Operator Passcode	Controls access to various operator functions. <ul style="list-style-type: none"> <li>• Range 000000 (Default) to 999999</li> </ul>
TIME	Time settings		Configure the date and time settings.
	TI.FMT	Time format	Sets the time format for the indicator. <ul style="list-style-type: none"> <li>• 12 (Default)</li> <li>• 24</li> </ul>

	DA.FMT	Date format	Set the date format for the indicator. <ul style="list-style-type: none"> <li>• DD.MM.YY</li> <li>• DD.MM.Y4</li> <li>• MM.DD.YY (Default)</li> <li>• MM.DD.Y4</li> <li>• YY.MM.DD</li> <li>• Y4.MM.DD</li> </ul>
	SET.TI	Time set	Set the time as prompted (Local function only): <ul style="list-style-type: none"> <li>• Hours: Enter hours (01-12 for SETUP:TI.FMT=12, 00 - 23 for SETUP:TI.FMT=24)</li> <li>• Min: Enter minutes (00 - 59)</li> <li>• Sec: Enter seconds (00 - 59)</li> <li>• AM PM: Enter AM or PM for SETUP:TI.FMT=12, not available for SETUP:TI.FMT=24</li> </ul>
	SET.DA	Date set	Set the current date as prompted (Local function only): <ul style="list-style-type: none"> <li>• Year: Enter year (2000 - 2099)</li> <li>• Month: Enter month (01 - 12)</li> <li>• Day: Enter day (01 - 31)</li> </ul>
KEY.LOC	Front panel key locking		Access to each of the operator functions can be configured separately by locking and unlocking individual keys. The display shows LOCKED to indicate that a key is locked (inactive). Functions protected with a 'Safe' Passcode prompt for the Passcode every time. Entering the Operator Passcode unlocks all operator protected functions so the operator is not continually prompted for the Passcode.
	POWER	Power key lock	<ul style="list-style-type: none"> <li>• AVAIL (Default): Function always available</li> <li>• OPER.PC: Requires a valid Operator Passcode</li> <li>• SAFE.PC: Requires a valid Safe Passcode</li> <li>• LOCKED: Function never available</li> </ul>
	ZERO	Fixed function keys	
	TARE		
	SELECT		
	UNIT		
	F1	Programmable function keys	
	F2		
DISP	Display settings		These settings control the operation of the display.
	B.LIGHT	Backlight operation	Sets the operation of the backlight. <ul style="list-style-type: none"> <li>• OFF: Backlight is off.</li> <li>• ON (Default): Backlight is on when weight motion, network communications or any keypress is detected.</li> <li>• AUTO: The brightness is lowered automatically to conserve power and the backlight will automatically turn off after a specified duration of inactivity. To turn on again, press the POWER key.</li> </ul>
	BL.TIME	Backlight power down time (s)	The backlight can be set up to automatically power down after a period of no activity (B.LIGHT=AUTO).

			Weight motion, network communications or any press of the keys is enough to keep the backlight on. <ul style="list-style-type: none"> <li>• 15 (Default)</li> <li>• 30</li> <li>• 60</li> <li>• 300</li> </ul>
	FREQ	Display update frequency (Hz)	Sets how often the display is updated. <ul style="list-style-type: none"> <li>• 1</li> <li>• 2</li> <li>• 5</li> <li>• 10 (Default)</li> </ul>
	BL.LVL	Display brightness level	Sets the brightness level of the display. <ul style="list-style-type: none"> <li>• Range 0% (Backlight off) to 100% (maximum brightness)</li> <li>• Default: 60%</li> </ul>
POWER	Power settings		Configure power settings of the unit.
	AUT.OFF	Auto power off (min)	The instrument can be set up to automatically power down after set minutes of activity. Weight motion, network communications or any press of the keyboard is enough to keep the instrument powered on. <ul style="list-style-type: none"> <li>• OFF (Default)</li> <li>• 5</li> <li>• 10</li> <li>• 20</li> <li>• 30</li> <li>• 60</li> </ul>
BUZZER	Buzzer enable		Configure the Buzzer. <ul style="list-style-type: none"> <li>• OFF: The buzzer is turned off</li> <li>• ON (Default): The buzzer is turned on</li> </ul>
USR.DEF	Indicator defaults		Set the non-calibration settings to defaults. Local function only.

## 5.2 Scale

SCALE	Scale base configuration		Scale Base configuration settings.
L2	L3	Short Description	Description
BUILD	Scale build		Settings within this Group are used to configure the indicator to suit the current application. It is important to fully set the options within this group before calibration is attempted. Later changes to items within this group may invalidate the current calibration data.
	TYPE	Range type	Range type. <ul style="list-style-type: none"> <li>• SINGLE (Default): Single range</li> <li>• DUAL.I: Dual interval</li> <li>• DUAL.R: Dual range</li> <li>• TRIPL.I: Triple interval</li> <li>• TRIPL.R: Triple range</li> </ul>
	DP1	Decimal point position	Sets the location of the decimal point on the display. To avoid confusion, set this parameter first so that all other weight related values are displayed with the decimal point in the correct position. <ul style="list-style-type: none"> <li>• 000000 (Default)</li> <li>• 00000.0</li> <li>• 0000.00</li> <li>• 000.000</li> <li>• 00.0000</li> <li>• 0.00000</li> </ul>
	CAP.1	Capacity of scale/ range 1/ interval 1	Sets the nominal maximum capacity (or full scale) of the scale. This is set in weighing units (e.g. kg, t, etc.), with the decimal point in place. For example, if a scale is to weigh 500.0 kg in 0.5 kg increments, CAP is set to 500.0, and RES is set to 5. If using multiple interval/range, this sets the fullscale capacity of the lowest range/interval. <ul style="list-style-type: none"> <li>• Range: 000001 to 999999</li> <li>• Default: 010000</li> </ul>
	E1	Resolution of scale/ range 1/ interval 1	Sets the resolution (or Count-by) of the display. The resolution is the number by which the indicator will count. If using multiple interval/range, this sets the count-by (or resolution) of the lowest range/interval. <ul style="list-style-type: none"> <li>• 1 (Default)</li> <li>• 2</li> <li>• 5</li> <li>• 10</li> <li>• 20</li> <li>• 50</li> <li>• 100</li> </ul>

	DP2	Decimal point position	<p>Sets the location of the decimal point on the display. To avoid confusion, set this parameter first so that all other weight related values are displayed with the decimal point in the correct position. (TYPE=DUAL.I, DUAL.R, TRIPLE.I, TRIPL.R)</p> <ul style="list-style-type: none"> <li>• 000000 (Default)</li> <li>• 00000.0</li> <li>• 0000.00</li> <li>• 000.000</li> <li>• 00.0000</li> <li>• 0.00000</li> </ul>
	CAP.2	Capacity of scale/ range 2/ interval 2	<p>Sets the nominal maximum capacity (or full scale) of the scale. This is set in weighing units (e.g. kg, t, etc.), with the decimal point in place. For example, if a scale is to weigh 500.0 kg in 0.5 kg increments, CAP is set to 500.0, and RES is set to 5. If using multiple interval/range, this sets the fullscale capacity of the lowest range/interval. (TYPE=DUAL.I, DUAL.R, TRIPLE.I, TRIPL.R)</p> <ul style="list-style-type: none"> <li>• Range: 000001 to 999999</li> <li>• Default: 020000</li> </ul>
	E2	Resolution of scale/ range 2/ interval 2	<p>Sets the resolution (or Count-by) of the display. The resolution is the number by which the indicator will count. If using multiple interval/range, this sets the count-by (or resolution) of the lowest range/interval. (TYPE=DUAL.I, DUAL.R, TRIPLE.I, TRIPL.R)</p> <ul style="list-style-type: none"> <li>• 1</li> <li>• 2 (Default)</li> <li>• 5</li> <li>• 10</li> <li>• 20</li> <li>• 50</li> <li>• 100</li> </ul>
	DP3	Decimal point position	<p>Sets the location of the decimal point on the display. To avoid confusion, set this parameter first so that all other weight related values are displayed with the decimal point in the correct position. (TYPE=TRIPLE.I, TRIPL.R)</p> <ul style="list-style-type: none"> <li>• 000000 (Default)</li> <li>• 00000.0</li> <li>• 0000.00</li> <li>• 000.000</li> <li>• 00.0000</li> <li>• 0.00000</li> </ul>

	CAP.3	Capacity of scale/ range 3/ interval 3	<p>Sets the nominal maximum capacity (or full scale) of the scale. This is set in weighing units (e.g. kg, t, etc.), with the decimal point in place. For example, if a scale is to weigh 500.0 kg in 0.5 kg increments, CAP is set to 500.0, and RES is set to 5.</p> <p>If using multiple interval/range, this sets the fullscale capacity of the lowest range/interval. (TYPE=TRIPLE.I, TRIPL.R)</p> <ul style="list-style-type: none"> <li>• Range: 000001 to 999999</li> <li>• Default: 050000</li> </ul>
	E3	Resolution of scale/ range 3/ interval 3	<p>Sets the resolution (or Count-by) of the display. The resolution is the number by which the indicator will count.</p> <p>If using multiple interval/range, this sets the count-by (or resolution) of the lowest range/interval. (TYPE=TRIPLE.I, TRIPL.R)</p> <ul style="list-style-type: none"> <li>• 1</li> <li>• 2</li> <li>• 5 (Default)</li> <li>• 10</li> <li>• 20</li> <li>• 50</li> <li>• 100</li> </ul>
	P.UNIT	Primary weighing units	<p>Sets the primary weighing units of the scale for display and printing.</p> <ul style="list-style-type: none"> <li>• kg: Kilograms (Default)</li> <li>• lb: Pounds</li> <li>• t: Tonnes</li> <li>• TN: Tons</li> <li>• g: Grams</li> <li>• oz: Ounces</li> <li>• N: Newton</li> <li>• kN: Kilo newton</li> </ul>
	UNIT.2	Secondary weighing units	<p>Sets the secondary weighing units for the scale.</p> <ul style="list-style-type: none"> <li>• OFF: Off (Default)</li> <li>• g: Grams</li> <li>• kg: Kilograms</li> <li>• t: Tonnes</li> <li>• lb: Pounds</li> <li>• oz: Ounces</li> <li>• lb oz: Pounds Ounces</li> <li>• TN: Tons</li> <li>• CUSTOM: Custom units</li> </ul>
	UNIT.3	Tertiary weighing units	<p>Sets the tertiary weighing units for the scale.</p> <ul style="list-style-type: none"> <li>• OFF: Off (Default)</li> <li>• g: Grams</li> <li>• kg: Kilograms</li> <li>• t: Tonnes</li> <li>• lb: Pounds</li> <li>• oz: Ounces</li> </ul>



			<ul style="list-style-type: none"> <li>• lb oz: Pounds Ounces</li> <li>• TN: Tons</li> </ul>
	D.UNIT	Custom unit	<p>Set the symbols to use for a custom defined unit on the instrument display (UNIT.2=CUSTOM).</p> <ul style="list-style-type: none"> <li>• NONE (Default)</li> <li>• L: Lower case "l" for litres</li> <li>• ARROW.U: Upper unit arrow</li> </ul>
	U.NAME	Custom unit name	<p>Sets the name of the custom unit (UNIT.2=CUSTOM).</p>
	FACTOR	Conversion factor	<p>Conversion factor for the custom unit (UNIT.2=CUSTOM).</p> <ul style="list-style-type: none"> <li>• Range: 0.001 to 999.999</li> <li>• Default: 1.000</li> </ul>
	HI.RES	x10 expanded mode	<p>Sets the instrument to display weight at 10 times resolution. This is intended for test purposes in trade applications but may be used for industrial weighing. This mode is indicated by the flashing of the unit's annunciator.</p> <ul style="list-style-type: none"> <li>• OFF (Default)</li> <li>• ON</li> </ul>
OPTION	Scale options		
	USE	Trade use	<p>This is where the basic use of the scale is set. This setting configures the instrument for Industrial, OIML, or NTEP operation.</p> <ul style="list-style-type: none"> <li>• INDUST (Default): Industrial (no standard)</li> <li>• OIML: OIML trade mode</li> <li>• NTEP: NTEP trade mode</li> </ul>
	FILTER	Reading average	<p>The instrument can average a number of consecutive readings when calculating the displayed weight. This is used to dampen unwanted weight fluctuations caused by vibrations or dynamic forces. High settings will stabilize the display at the expense of rapid response to sudden weight changes.</p> <ul style="list-style-type: none"> <li>• OFF</li> <li>• LOW</li> <li>• MED (Default)</li> <li>• HIGH</li> <li>• V.HIGH</li> </ul>
	MOTION	Motion detection sensitivity	<p>Sets how much weight variation over a defined time period is allowed before the displayed weight is deemed to be unstable. This setting is given as <math>xd - yt</math> where weight change of more than <math>x</math> divisions in <math>y</math> seconds will trigger motion. This value is displayed as weight change (0.5 or 1.0 graduations)</p>

			<p>per second. When set to OFF, the Motion Detection is ignored and ZERO, TARE and PRINT actions are instantaneous.</p> <ul style="list-style-type: none"> <li>• OFF, 0.5-1.0, 1.0-1.0, 2.0-1.0, 3.0-1.0, 5.0-1.0, 0.5-0.5, 1.0-0.5, 2.0-0.5, 3.0-0.5, 5.0-0.5, 0.5-0.2, 1.0-0.2, 2.0-0.2, 3.0-0.2, 5.0-0.2 (graduations per second)</li> <li>• Default: 0.5-1.0 (0.5 graduations per second)</li> </ul>
Z.RANGE	Allowable zero operating range		<p>This setting restricts the range over which the Zero functions can operate.</p> <ul style="list-style-type: none"> <li>• OFF</li> <li>• -2_2</li> <li>• -1_3 (-1% to +3%) (Default)</li> <li>• -10_10</li> <li>• -20_20</li> <li>• FULL</li> </ul>
Z.TRACK	Zero tracking sensitivity		<p>Zero tracking allows the display to adjust for minor changes in the zero balance of the scale. When enabled, the instrument will track weight readings within the zero 'dead' band back to exactly zero at a maximum rate of graduations per second.</p> <ul style="list-style-type: none"> <li>• OFF (Default)</li> <li>• 0.5</li> <li>• 1</li> <li>• 2</li> <li>• 3</li> <li>• 5</li> </ul>
Z.INIT	Initial-zero on start-up		<p>Enables the zero-on-start-up feature. When enabled, a zero will be performed as part of the instrument start-up procedure if the scale is within the zero range. This function can be used to automatically ZERO the indicator during power-up. The amount of weight that can be zeroed is limited to +/- 10% of full scale.</p> <ul style="list-style-type: none"> <li>• ON</li> <li>• OFF (Default)</li> </ul>
Z.BAND	Zero 'dead' band		<p>Sets the weight range around zero which will be considered zero for application purposes. This is an adjustable margin either side of true zero that defines the zero 'dead' band. The zero 'dead' band is used by the automated functions to determine zero load (e.g. a setting of 4 specifies that readings between -4.5 and 4.5 are considered to be zero). When the displayed weight reading is within this band the instrument displays the zero band annunciator. Settable over the full weight range. Always enter a number in multiples of display units.</p> <ul style="list-style-type: none"> <li>• Range: -1 to 999999</li> <li>• Default: 0 (i.e. -0.5 to 0.5 graduations)</li> </ul>

	R.ENTRY	Rear entry	Full access via the rear setup button only. This option is only available when the rear setup button has been used to access the menu system. <ul style="list-style-type: none"> <li>• ON</li> <li>• OFF (Default)</li> </ul>
	PT.CLR	Preset tare clear	Sets if the preset tare is cleared by the tare key or not. <ul style="list-style-type: none"> <li>• OFF: Preset tare is not cleared by the tare key. Both preset tare and user tare will be active at the same time.</li> <li>• TARE (Default): Preset tare is cleared by the tare key.</li> </ul>
CAL	Scale calibration		Items within this group perform various calibration routines. Certain items in the Scale Build can affect the calibration of the scale. Always check that these sections are correctly configured to suit the current application before attempting to calibrate the scale.
	ZERO	Zero calibration	Select to perform Zero Calibration. While the zeroing is in progress the display will show Z.in P
	SPAN	Span calibration	Perform a span calibration. A zero calibration should be done before doing a span calibration. While the span calculation is in progress the display will show S.in P.
	ED.LIN	Edit linearisation points	Select to view linearisation setup and start linearisation routines. While linearisation is in progress the display will show L.in P.
	CLR.LIN	Clear linearisation points	Select to view linearisation setup and select linearisation points to clear.
	DIR.ZER	Direct mV/V zero calibration	Enter signal strength (in mV/V) of zero calibration directly.
	DIR.SPAN	Direct mV/V span calibration	Enter the signal strength (in mV/V) of fullscale directly. No test weights required.
	DEF.CAL	Default calibration (all scale settings to defaults)	Restore instrument to default factory calibration and reset all items in the SCALE menu to defaults.
GRAVITY	Gravity		Used to compensate for the change in gravitational acceleration between locations.
	G.COMP	Gravity compensation	Enables the gravitational acceleration compensation feature. <ul style="list-style-type: none"> <li>• OFF (Default): Disable gravity compensation</li> <li>• ON: Enable gravity compensation</li> </ul>
	G.FACT	Factory gravitational acceleration	Sets the gravitational acceleration of the factory location. <ul style="list-style-type: none"> <li>• Range: 9.750 to 9.860</li> <li>• Default: 9.810</li> </ul>

	G.INST	Installation gravitational acceleration	Sets the gravitational acceleration of the installation location. <ul style="list-style-type: none"> <li>• Range: 9.750 to 9.860</li> <li>• Default: 9.810</li> </ul>
	G.FIRST	Gravitational acceleration first setting	When set, the indicator will prompt for the installation gravitational acceleration on the next power on. <ul style="list-style-type: none"> <li>• OFF (Default): Disable prompt for installation gravitational acceleration on the next power on</li> <li>• ON: Enable prompt for installation gravitational acceleration on the next power on</li> </ul>
QA	Quality assurance		Configure the quality assurance feature. If active the instrument displays a 'QA DUE' warning after the date limit has expired.
	QA.OPT	QA enable	Turn QA feature on or off. <ul style="list-style-type: none"> <li>• ON</li> <li>• OFF (Default)</li> </ul>
	YEAR	QA expiry date	Enter QA expiry date - year <ul style="list-style-type: none"> <li>• Range: 2020 (Default) - 2099</li> </ul> This item is trade critical and will affect the calibration counter(s) if changed.
	MONTH	QA expiry date	Enter QA expiry date - month <ul style="list-style-type: none"> <li>• Range: 1 (Default) - 12</li> </ul> This item is trade critical and will affect the calibration counter(s) if changed.
	DAY	QA expiry date	Enter QA expiry date - day <ul style="list-style-type: none"> <li>• Range: 1 (Default) - 31</li> </ul> This item is trade critical and will affect the calibration counter(s) if changed.

## 5.3 Serial

SERIAL	Serial output		Serial output settings.	
L2	L3	L4	Short Description	Long Description
HEADER			Printout header	Sets the print docket header.
FOOTER			Printout footer	Sets the print docket footer.
SER1-SER3	Serial port 1-3			Settings for serial port 1-3.
	BAUD		Baud rate	Sets the baud rate for the port. <ul style="list-style-type: none"> <li>• 1200</li> <li>• 2400</li> <li>• 4800</li> <li>• 9600 (Default)</li> <li>• 19200</li> <li>• 38400</li> <li>• 57600</li> <li>• 115200</li> </ul>
	DATA		Data bits	Sets the number of data bits for the port. <ul style="list-style-type: none"> <li>• 8 (Default)</li> <li>• 7</li> </ul>
	PARITY		Parity	Sets the parity for the port. <ul style="list-style-type: none"> <li>• P NONE (Default)</li> <li>• P EVEN</li> <li>• P ODD</li> </ul>
	STOP		Stop bits	Sets the number of stop bits for the port. <ul style="list-style-type: none"> <li>• 1 (Default)</li> <li>• 2</li> </ul>
	SER.NET	Serial network		Configure the serial networking support.
		ADDR	Network address	Address of instrument <ul style="list-style-type: none"> <li>• Range: 1 (Default) - 31</li> </ul>
		TYPE	Protocol type	Sets the network protocol type. <ul style="list-style-type: none"> <li>• NONE</li> <li>• RINCMD (Default)</li> <li>• SIMPLE</li> <li>• REMOTE</li> </ul>
	SER.AUT	Automatic serial output		Settings for automatic serial outputs.
		FORMAT	Format	Sets the data format. <ul style="list-style-type: none"> <li>• FMT.A (Default) to FMT.I and CUSTOM</li> </ul>
		AUTO.SPD	Serial output frequency	Sets the serial output frequency <ul style="list-style-type: none"> <li>• SINGLE (Default)</li> <li>• FULL</li> <li>• 10Hz</li> <li>• 5Hz</li> <li>• 2Hz</li> </ul>

			<ul style="list-style-type: none"> <li>• 1Hz</li> </ul>	
		SOURCE	Weight data source Sets the weight data to send. <ul style="list-style-type: none"> <li>• P.GROSS</li> <li>• P.NET</li> <li>• P.DISP</li> <li>• P.NET.PT</li> <li>• D.GROSS</li> <li>• D.NET</li> <li>• D.DISP (Default)</li> <li>• D.NET.PT</li> </ul>	
	PRINT	Printout settings		Configures the printout settings.
		FORMAT	Printout format Sets the printout format. <ul style="list-style-type: none"> <li>• FMT.A (Default)</li> <li>• FMT.B</li> <li>• CUSTOM</li> </ul>	
		TYPE	Printout type Sets the printout type. <ul style="list-style-type: none"> <li>• NONE</li> <li>• RECORD (Default)</li> <li>• DOCKET</li> </ul>	
		ACCUM	Accumulation Enables total accumulation. <ul style="list-style-type: none"> <li>• OFF (Default)</li> <li>• ON</li> </ul> When set to ON, it adds the current weight to the TOTAL for each print event. Note there is one accumulation for the instrument but there is a total for each unit, Gross and Net..	
		AUTO	Automatic printing Sets whether printing occurs automatically. <ul style="list-style-type: none"> <li>• NO (Default)</li> <li>• YES</li> </ul>	
		IL.TYPE	Interlock type Sets the type of printing interlock to be used. <ul style="list-style-type: none"> <li>• NONE (Default): No interlock type</li> <li>• MOTION: Printing is enabled every time the scale becomes stable.</li> <li>• I.LOCK: Printing is enabled when the weight is stable after a weight movement larger than the interlock weight.</li> <li>• RET.Z: Printing is enabled after the scale has returned to zero and is stable at a reading other than zero.</li> </ul>	
		I.LOCK	Interlock weight Sets the interlock weight. <ul style="list-style-type: none"> <li>• Range 000000 (Default) to 999999</li> </ul>	
		P.WIDTH	Page width Sets the page width. A setting of zero disables page width checking. <ul style="list-style-type: none"> <li>• Range 0 (Default) to 80</li> </ul>	

---

		SP.TOP	Top spacing	Sets the number of blank lines added to the top of the print out. <ul style="list-style-type: none"><li>• Range 0 (Default) to 10</li></ul>
		SP.LEFT	Left spacing	Sets the number of leading spaces added to each line of the print out. <ul style="list-style-type: none"><li>• Range 0 (Default) to 10</li></ul>
		SP.BOT	Bottom spacing	Sets the number of blank lines added to the bottom of the print out. <ul style="list-style-type: none"><li>• Range 0 (Default) to 10</li></ul>

## 5.4 Set Points

SETP	Setpoint settings		Configure setpoints.
L2	L3	Short Description	Long Description
SETP1- SETP8	Setpoint 1 to 8		Configuration settings for setpoint 1-8
	TYPE	Setpoint type	<p>Set set-point type. Options are:</p> <ul style="list-style-type: none"> <li>• OFF: Disabled (default)</li> <li>• ON: Always active</li> <li>• OVER: Weight over set-point</li> <li>• UNDER: Weight under set-point</li> <li>• COZ: Center of zero status</li> <li>• ZERO: Zero band status</li> <li>• NET: Gross/net status</li> <li>• MOTION: Motion status</li> <li>• ERROR: Error status</li> <li>• C.W.HI: Checkweigh high status</li> <li>• C.W.OK: Checkweigh OK status</li> <li>• C.W.LO: Checkweigh low status</li> <li>• W.IN: Weigh in</li> <li>• W.OUT: Weigh out</li> </ul>
	LOGIC	Output logic	<p>Output logic.</p> <ul style="list-style-type: none"> <li>• HIGH (Default): Forces the output to follow the setpoint activity, the output will be on when the setpoint is active.</li> <li>• LOW: Forces the output to the reverse of the setpoint activity, the output will be off when the setpoint is active.</li> </ul>
	TIMING	Output timing	<p>Select the timing which is applied to the setpoint output.</p> <ul style="list-style-type: none"> <li>• LEVEL (Default): Output is active when setpoint is active and reset is not active.</li> <li>• EDGE: Output is active when setpoint is active.</li> <li>• LATCH: will stay inactive after reset until the next setpoint transition from inactive to active.</li> </ul>
	TARGET	Target weight	<p>Sets the target weight. The flight weight must be taken into consideration when setting the target weight (TYPE=OVER, UNDER, W.IN, W.OUT).</p> <ul style="list-style-type: none"> <li>• Range -999999 (Default) to 999999</li> </ul>
	FLIGHT	Flight weight	<p>Sets the expected weight of material in flight (TYPE=OVER, UNDER, W.IN, W.OUT).</p> <ul style="list-style-type: none"> <li>• Range 000000 (Default) to 999999</li> </ul>
	HYS	Hysteresis	<p>Hysteresis defines the amount of weight required for an active setpoint to become inactive again (TYPE=OVER, UNDER, W.IN, W.OUT).</p> <p>A value of 0 still allows for 0.5 graduations of hysteresis.</p> <ul style="list-style-type: none"> <li>• Range 000000 (Default) to 999999</li> </ul>



	ALARM	Setpoint alarm	Alarms are triggered when the setpoint is active. <ul style="list-style-type: none"> <li>• NONE (Default): no alarm</li> <li>• SINGLE: single BEEP</li> <li>• DOUBLE: double BEEP</li> <li>• FLASH: flash display</li> </ul>
	B.LIGHT	Backlight color	Sets the backlight color to display when the setpoint is active. <ul style="list-style-type: none"> <li>• NONE (Default)</li> <li>• WHITE</li> <li>• RED</li> <li>• GREEN</li> <li>• BLUE</li> <li>• ORANGE</li> <li>• PURPLE</li> <li>• TEAL</li> <li>• AMBER</li> </ul>
	SOURCE	Source weight	Select which weight values the setpoint checks against the target weight (TYPE=OVER, UNDER, ZERO, W.IN, W.OUT). <ul style="list-style-type: none"> <li>• GROSS: Gross weight always</li> <li>• NET: Net weight always</li> <li>• GR.or.NT: Gross or Net depending on which one is displayed.</li> <li>• PIECE: Gross or Net Piece count depending on which one is displayed</li> <li>• NET.PT: Net preset tare</li> </ul>
	RESET	Disable setpoint	Input to disable the setpoint. <ul style="list-style-type: none"> <li>• NONE (Default), IO1 to IO8</li> </ul>
	NAME	Name of the setpoint	Setpoint name. Used in the target function key to identify the setpoint.

## 5.5 App

APP			
L2	L3	Short Description	Long Description
P.COUNT	Piece count		Counting functions are preformed by P.COUNT special function. <ul style="list-style-type: none"> <li>• OFF (Default)</li> <li>• WEIGHT: Allows the operator to enter piece weight directly.</li> <li>• RESAMP: Allows you to keep adding pieces to adjust the sample size.</li> </ul>
CHECK.W	Check weighing		This allows the gross/net weight, displayed weight or pieces to be chosen as the source for the setpoint operation. This allows the over, under and tartget limits to be linked to gross/net weights, pieces values.
	CW.MODE	Check weighing mode	Configures the checkweighing behaviour. <ul style="list-style-type: none"> <li>• OFF (Default): Disablecheckweighing</li> <li>• ABS: Enable absolute checkweighing</li> <li>• REL: Enable relative checkweighing</li> </ul>
	CW.SRC	Check weighing source	This allows to choose what weight/Pieces value to be used to set TARGET, HIGH and LOW levels (CW.MODE=ABS, REL). <ul style="list-style-type: none"> <li>• GROSS</li> <li>• NET</li> <li>• GR.or.NT ( Default)</li> <li>• PIECE</li> <li>• NET.PT</li> </ul>
	CW.CTRL	Check weighing control	Sets when the check weighing function is active (CW.MODE=ABS, REL). <ul style="list-style-type: none"> <li>• NONE (Default)</li> <li>• ZERO</li> <li>• MOTION</li> </ul>
	CW.HIGH	Check weighing upper level weight	Sets the higher threshold of the check weigh range (CW.MODE=ABS). <ul style="list-style-type: none"> <li>• Range: -99999 to 999999</li> <li>• Default: 001100</li> </ul>
	CW.LOW	Check weighing lower level weight	Sets the lower threshold of the check weigh range (CW.MODE=ABS). <ul style="list-style-type: none"> <li>• Range -99999 to 999999</li> <li>• Default: 000900</li> </ul>
	CW.TARG	Check weighing target	Sets the target check weight (CW.MODE=REL) <ul style="list-style-type: none"> <li>• Range -99999 to 999999</li> <li>• Default: 005000</li> </ul>
	CW.TOL.H	Check weighing upper tolerance	Sets the upper tolerance for relative check weighing (CW.MODE=REL).

			<ul style="list-style-type: none"> <li>• Range: -99999 to 999999</li> <li>• Default: 001100</li> </ul>
	CW.TOL.L	Check weighing lower tolerance	<p>Sets the lower tolerance for relative check weighing (CW.MODE=REL).</p> <ul style="list-style-type: none"> <li>• Range -99999 to 999999</li> <li>• Default: 000900</li> </ul>
A.TARE	Auto tare		The option is used to enable the automatic tare feature. This feature when enabled will cause the indicator to be tared whenever the weight is motionless above the auto-tare threshold and has been below the auto-tare threshold since the last auto-tare.
	A.TARE	Auto tare input	<p>Input to set the preset tare to the current gross weight.</p> <ul style="list-style-type: none"> <li>• OFF (Default)</li> <li>• ON.CLR</li> <li>• ON.AUTO</li> </ul>
	CLR.DLY	Clear delay (s)	<p>Delay before returning to gross weight when inside the zero band.</p> <ul style="list-style-type: none"> <li>• Range 0.0 to 10.0</li> <li>• Default: 1.0</li> </ul>
	THRESH	Weight threshold	<p>Weight threshold to reach before automatically taring.</p> <ul style="list-style-type: none"> <li>• Range: 0 (Default) to 999999</li> </ul>
F1, F2 KEYS	Special function Key 1-2		Configures special function keys 1-2
	TYPE	Function type	<p>Sets the function type.</p> <ul style="list-style-type: none"> <li>• NONE (Default)</li> <li>• PRINT: Triggers a printout</li> <li>• SINGLE: Triggers a single serial weight transmission</li> <li>• TEST: Display test</li> <li>• UNITS: Triggers unit switching</li> <li>• HOLD: Manual hold</li> <li>• PK.HOLD: Peak hold</li> <li>• REM.KEY: Remote key operation</li> <li>• BLANK: Blanking input</li> <li>• HI.RES: High resolution mode toggle</li> <li>• LIVE: Implements live weighing</li> <li>• TOTAL: Totalisation</li> <li>• TARGET: Target</li> <li>• FUNC.EN: Function enable</li> </ul>
	PRT.OUT	Printout	<p>Configuration of the PRINT Special Function (TYPE=PRINT). Printouts are configured in the SERIAL menu.</p> <ul style="list-style-type: none"> <li>• SER 1 (Default)</li> <li>• SER 2</li> <li>• SER 3</li> </ul>

AUTO.OUT	Auto output serial	Choose which Auto Output Serial service to trigger (TYPE=SINGLE). Single serial outputs are similar to printing but do not support any interlocking or totalising functions. <ul style="list-style-type: none"> <li>SER 1 (Default)</li> <li>SER 2</li> <li>SER 3</li> </ul>
P.HOLD	Peak hold	A peak hold key/input implements a peak hold where the largest absolute weight, either positive or negative is stored and displayed (TYPE=PK.HOLD). <ul style="list-style-type: none"> <li>ALWAYS</li> <li>STABLE (Default)</li> </ul>
REM.KEY	Remote key function	Allows for external inputs to be used to trigger instrument key functions (TYPE=REM.KEY). The external 'keys' operate even if the instrument keys are locked and never require Operator or Setup passcodes to be entered. <ul style="list-style-type: none"> <li>NONE (Default)</li> <li>ZERO</li> <li>TARE</li> <li>SELECT</li> </ul>
BLANK	Blanking function	Blanking functions enable the detection of external inputs to be used to block instrument operation by blanking the screen and blocking key functions (TYPE=BLANK). <ul style="list-style-type: none"> <li>DASH (Default): Fill instrument display with '-' characters</li> <li>BLANK: completely blank instrument display</li> </ul>
DELAY	Time delay (s)	The time in seconds that the indicator will wait after the threshold weight is exceeded before it starts collecting weight samples (TYPE=LIVE). <ul style="list-style-type: none"> <li>Range: 0.0 to 20.0</li> <li>Default: 1.0</li> </ul>
SAMPLE	Sample time	The number of seconds worth of weight samples to collect (TYPE=LIVE). <ul style="list-style-type: none"> <li>Range: 1 to 20</li> <li>Default: 4</li> </ul>
TOL	Number of discards	Available when TYPE=LIVE. Indication of what percentage of noisy samples will be discarded from upper and lower ends. <ul style="list-style-type: none"> <li>Range: 0 to 75</li> <li>Default: 30</li> </ul>
RETRIG	Retrigger percentage	This is the percentage that the weight on the scale must change by to restart the live weighing process once a held weight has been captured (TYPE=LIVE). A value of 0 means that automatic retriggering is disabled.

			<ul style="list-style-type: none"> <li>• Range: 0 (Default) to 30</li> </ul>
	THRESH	Threshold weight	<p>The weight to be exceeded before the indicator will start the livestock weighing function (TYPE=LIVE).</p> <ul style="list-style-type: none"> <li>• Range -99999 to 999999</li> <li>• Default: 0</li> </ul>
	IDLE	Idle time (s)	<p>Idle time before timeout (TYPE=LIVE).</p> <ul style="list-style-type: none"> <li>• Range: 1 to 20</li> <li>• Default: 5</li> </ul>
IN 1 - IN 2	Input 1-2		Configures inputs 1 and 2
	TYPE	Input type	<p>Sets the input type.</p> <ul style="list-style-type: none"> <li>• NONE (Default)</li> <li>• PRINT: Triggers a printout</li> <li>• SINGLE: Triggers a single serial weight transmission</li> <li>• TEST: Display test</li> <li>• UNITS: Triggers unit switching</li> <li>• HOLD: Manual hold</li> <li>• PK.HOLD: Peak hold</li> <li>• REM.KEY: Remote key operation</li> <li>• BLANK: Blanking input</li> <li>• HI.RES: High resolution mode toggle</li> <li>• LIVE: Implements live weighing</li> <li>• TOTAL: Totalisation</li> <li>• TARGET: Target</li> <li>• FUNC.EN: Function enable</li> </ul>
	PRT.OUT	Printout	<p>Configuration of the PRINT Special Function (TYPE=PRINT). Printouts are configured in the SERIAL menu.</p> <ul style="list-style-type: none"> <li>• SER 1 (Default)</li> <li>• SER 2</li> <li>• SER 3</li> </ul>
	AUTO.OUT	Auto output serial	<p>Choose which Auto Output Serial service to trigger (TYPE=SINGLE). Single serial outputs are similar to printing but do not support any interlocking or totalising functions.</p> <ul style="list-style-type: none"> <li>• SER 1 (Default)</li> <li>• SER 2</li> <li>• SER 3</li> </ul>
	P.HOLD	Peak hold	<p>A peak hold key/input implements a peak hold where the largest absolute weight, either positive or negative is stored and displayed (TYPE=PK.HOLD).</p> <ul style="list-style-type: none"> <li>• ALWAYS</li> <li>• STABLE (Default)</li> </ul>
	REM.KEY	Remote key function	<p>Allows for external inputs to be used to trigger instrument key functions (TYPE=REM.KEY). The</p>

			<p>external 'keys' operate even if the instrument keys are locked and never require Operator or Setup passcodes to be entered.</p> <ul style="list-style-type: none"> <li>• NONE (Default)</li> <li>• ZERO</li> <li>• TARE</li> <li>• SELECT</li> </ul>
	BLANK	Blanking function	<p>Blanking functions enable the detection of external inputs to be used to block instrument operation by blanking the screen and blocking key functions (TYPE=BLANK).</p> <ul style="list-style-type: none"> <li>• DASH (Default): Fill instrument display with '-' characters</li> <li>• BLANK: completely blank instrument display</li> </ul>
	DELAY	Time delay (s)	<p>The time in seconds that the indicator will wait after the target weight is exceeded before it starts collecting weight samples (TYPE=LIVE).</p> <ul style="list-style-type: none"> <li>• Range: 0.0 to 20.0</li> <li>• Default: 1.0</li> </ul>
	SAMPLE	Sample time	<p>The number of seconds worth of weight samples to collect (TYPE=LIVE).</p> <ul style="list-style-type: none"> <li>• Range: 1 to 20</li> <li>• Default: 4</li> </ul>
	TOL	Number of discards	<p>Available when TYPE=LIVE. Indication of what percentage of noisy samples will be discarded from upper and lower ends.</p> <ul style="list-style-type: none"> <li>• Range: 0 to 75</li> <li>• Default: 30</li> </ul>
	RETRIG	Retrigger percentage	<p>This is the percentage that the weight on the scale must change by to restart the live weighing process once a held weight has been captured (TYPE=LIVE). A value of 0 means that automatic retriggering is disabled.</p> <ul style="list-style-type: none"> <li>• Range: 0 (Default) to 30</li> </ul>
	THRESH	Threshold weight	<p>The weight to be exceeded before the indicator will start the livestock weighing function (TYPE=LIVE).</p> <ul style="list-style-type: none"> <li>• Range -99999 to 999999</li> <li>• Default: 0</li> </ul>
	IDLE	Idle time (s)	<p>Idle time before timeout (TYPE=LIVE).</p> <ul style="list-style-type: none"> <li>• Range: 1 to 20</li> <li>• Default: 5</li> </ul>

**5.6 Test**

TEST		
L2	Short Description	Long Description
DISP	Display test	Test the display by displaying all segments turned on and off.
MVV	mV/V test mode	Show the loadcell signal in mV/V.
OUT.TST	Test digital outputs	Test digital outputs by setting outputs on or off. Use the Zero and Tare keys to select the output, and the Units and Gross/Net keys to toggle the value.
INP.TST	Test digital inputs	Display the digital input states.
OL.CNT	Overload count	Shows the number of times the instrument has been overloaded or underloaded by at least 50% of fullscale.
OL.CLR	Clear overload count	Clear the overload counter.
UPD	Micro volt per division	Display the uV per division value

**5.7 End**

Save and Close

## 6. CONFIGURATION

### 6.1 General Setup Information

Configuration and calibration can be performed entirely from the front panel, using the digital setup facility. When Full Setup is used, all menu items are accessible and care must be taken to ensure no accidental changes are made to calibration and trade settings. In addition, there is also Safe Setup that provides restricted access. This setup method ensures that only settings that are not calibration or trade sensitive can be changed. Full and Safe Setup can be passcode protected to prevent unauthorised or accidental tampering.

### 6.2 Correct Loadcell Selection

The following terms are used throughout the setup procedure.

Term	Definition
Units	Units of measurement (kilograms, tonnes, pounds, etc.).
Full Scale	Total change in weight between zero gross load and full capacity gross load.
Resolution or Count-by	Smallest change in weight units that the display can show.
Total Number of Graduations	Maximum number of display steps between zero gross load and full capacity gross load. It is equal to full scale divided by the count-by.
Division	A single graduation.

It is important to ensure the signal strength from the connected loadcells is sufficiently high to match the capability of the instrument, especially when configuring a trade certified site. The trade approved capability of the instrument is quoted as a maximum number of divisions with a minimum signal strength per division in micro-volts. To illustrate the process consider the following example:

#### Example

Four 2,500kg 2.0mV/V load cells are used in an application requiring a 5,000kg full scale, with weight displayed in 5kg increments.

The values are:

- Units = kg
- Full Scale = 5000
- Count-by = 5

Calculating the total number of graduations:	$\text{Total Number of Graduations} = \frac{\text{Full Scale}}{\text{Count-by}} = \frac{5000}{5} = 1000 \text{ divisions}$
Signal voltages can be calculated as follows:	



Calculating the full-scale signal (load cell):	$\text{Full Scale Signal} = \frac{\text{Full Scale Load Cell}}{\text{Capacity}} = \frac{5000}{10000} \times 2.0\text{mV/V} = 1.0\text{mV/V}$
Since the instrument uses 5V load cell excitation, the absolute signal voltage is:	$\text{Absolute Signal Voltage} = \text{Excitation Voltage} \times \text{Full Scale Signal} = 5\text{V} \times 1.0\text{mV/V} = 5.0\text{mV}$
Calculating the signal resolution:	$\text{Signal Resolution} = \frac{\text{Absolute Signal Voltage}}{\text{Number of Graduations}} = \frac{5.0\text{mV}}{1000 \text{ divisions}} = 0.005\text{mV / division} = 5\mu\text{V / division}$

### 6.3 Filtering Techniques

There is a trade off between noise filtering and the step-response time of the system. The step-response is defined as the time between placing a weight on the scale and the correct stable weight reading being displayed. This does not affect the number of readings per second that are taken. It simply defines the amount of time that is required to determine a final weight reading.

The FILTER setting in the instrument setup shows the amount of time over which the averaging is taken. Increasing the averaging time will result in a more stable reading but will extend the time it takes the instrument to settle to a final reading.

### 6.4 Industrial vs Trade Modes

The instrument may be operated in Industrial or Trade modes. These modes restrict certain aspects of the operation of the instrument to ensure compliance with trade certified standards.

Element	Industrial	OIML	NTEP
<b>Underload</b>	-105% of Fullscale	-20 divisions	-1% or -2% of Fullscale depending on zero range setting
<b>Overload</b>	105% of Fullscale	Fullscale + 9 divisions	105% of Fullscale
<b>Tare</b>	No restrictions	Tare values must be > 0	Tare values must be > 0
<b>Test Modes</b>	Unlimited time allowed	Limited to five seconds	Limited to five seconds

## 6.5 Calibration Counter

Within Setup there are critical steps that can affect the calibration and/or legal for trade performance of the instrument. If any of these steps are altered, the trade certification of the scale could be voided.

The instrument provides built-in calibration counter(s) to monitor the number of times the critical steps are altered. The value of a counter is stored within the instrument and can only be reset at the factory. Each time a critical step is altered, the counter will increase by one. Whenever the instrument is powered up, or setup mode is entered/exited, the current value in the counter is displayed briefly (eg. C00010).

The value of the counter is written on the tamperproof trade label on the front of the indicator for trade-certified applications and functions as an electronic seal. If any legal for trade settings are changed on the instrument, the current value of the calibration counter will be different from the recorded value and the seal is broken. In this manual, items marked with ⊗ indicate that the setting is legal for trade critical settings.

## 6.6 Passcodes (GEN.OPT:PCODE)

The instrument has three levels of passcode to provide security for instrument functions, calibration and general configuration. The Full Setup passcode can also be used to access Safe Setup and Operator functions. Instrument settings that are accessed by the communications are protected by the same passcodes.

**Full Setup Passcode:** Setting a passcode for Full Setup restricts access to Full Setup.

**Safe Setup Passcode:** Setting a passcode for Safe Setup restricts access to Safe Setup functions. In addition, front panel functions can be configured to prompt for a Safe Setup passcode before operating.

**Operator Passcode:** The operator passcode is used to protect access to instrument functions available from the front panel keypad. The operator generally needs to enter the Operator Passcode only once to gain access to multiple functions. To lock the instrument again press the '!' key for two seconds (LOCK function).

**Setup Lock-Out:** If an attempt is made to enter Full or Safe Setup using an incorrect passcode, the instrument will respond with the message ENTRY DENIED and then the user will be returned to normal operating mode.

No more than three failed attempts can be made to access Full/Safe Setup before the instrument blocks access completely. The instrument must be turned off and on again before further attempts can be made.

## 7. CALIBRATION (SCALE:CAL)

The calibration of the indicator is fully digital. The calibration results are stored in permanent memory for use each time the instrument is powered up.

Note: The BUILD and OPTION settings MUST be configured before calibration is attempted.

To perform a calibration, when in Full Setup select SCALE:CAL. The calibration programme will automatically prevent the instrument from being calibrated into an application outside of its specification. If an attempt is made to calibrate outside of the permitted range, an error message will display and the calibration will be abandoned. The instrument has a wide-range A/D converter. The industrial calibration range of the instrument extends well beyond the Trade approved range.

Note: It should not be assumed that just because the instrument has successfully calibrated a scale, that the scale is correct for trade use. Always check the scale build against the approval specification.

### 7.1 Performing a Digital Calibration with Test Weights

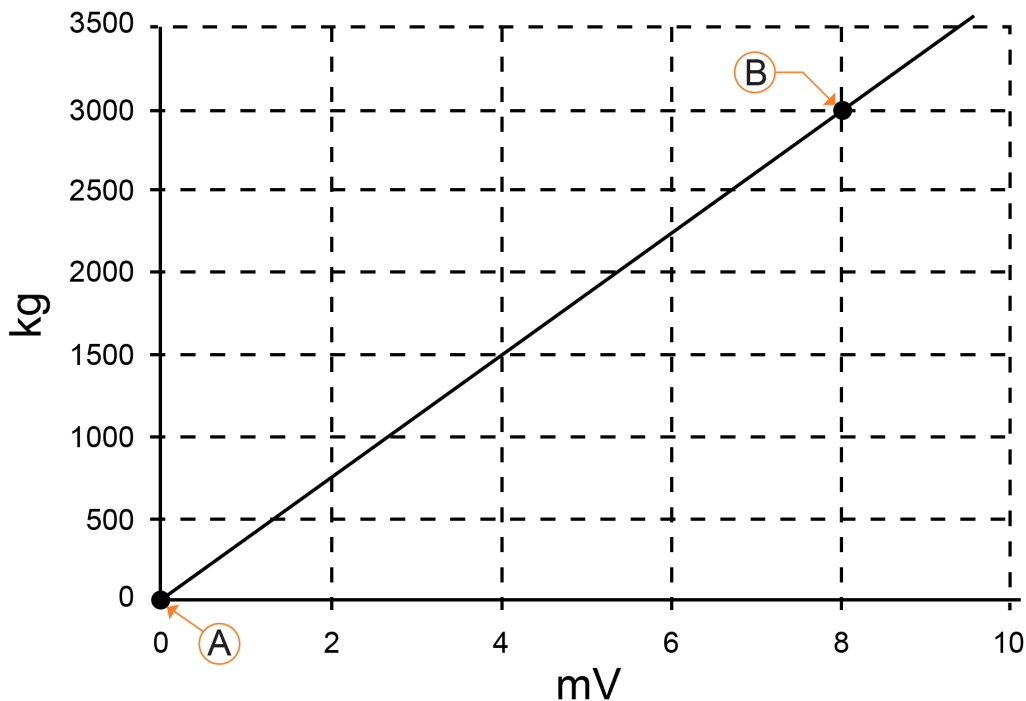

Figure 15: Zero and Span Points to Interpolate Weight from Load Cell

The Zero setting (CAL:ZERO) specifies a gross zero point for the scale. The Span setting (CAL:SPAN) specifies a second point (preferably close to full scale) used to convert the A/D readings into weighing units (e.g. kg). Select either of the Zero (CAL:ZERO) or Span (CAL:SPAN) calibration items. It is important that an initial Zero calibration is performed before any SPAN calibrations. The chart shown here demonstrates how the zero and span points are used to interpolate a weight reading from the load cell reading.

Notes:

1. Calibration points (Zero, Span and Linearisation) must be spaced by at least 2% of Full scale from each other.
2. First span point must be 10% of full scale or greater for successful calibration.

### 7.1.1 CAL:ZERO (Zero Calibration Routine)

- Press the <OK> key to start - the display will show the current weight.
- Remove all weight from the scale structure.
- Press <OK> to start a Zero Calibration routine - the display will show Z in P to indicate that zeroing is in progress.
- When complete the display show the weight
- Press the <OK> key to leave the routine and return to the CAL menu - use the menu navigation to finish setup.

### 7.1.2 CAL:SPAN (Span Calibration Routine)

- Press <OK> to start. The display will show the current weight. (\*)
- Add the calibration test mass to the scale where the closer the test weight is to full scale the better the accuracy. (The minimum acceptable span calibration weight is 2% of the scale range but a weight this small may limit calibration accuracy)
- Press <OK> to show the calibration weight and enter into edit mode.
- Use the <ARROW> keys to update the calibration weight.
- Press <OK> to start the Span Calibration routine - the display will show **S in P** to indicate that spanning is in progress
- When complete the display will show the weight.
- Press the <OK> key to leave the routine and return to the CAL menu - use the menu navigation to finish setup.

(\* Use CAL:CLR.LIN to clear linearisation points as required)

## 7.2 Performing a Calibration with Direct mV/V Entry

In applications where test weights are not easily available, it is possible to calibrate the instrument directly by entering the mV/V signal strength at Zero and full scale Span. The Direct Zero setting (CAL:DIR.ZER) specifies a gross zero point for the scale. The Direct Span setting (CAL:DIR.SPN)

specifies the mV/V signal strength corresponding to an applied mass equal to the full scale reading. This calibration technique is not compatible with linearisation. Clearly the accuracy of this type of calibration is limited to the accuracy of the direct mV/V data.

### 7.2.1 DIR.ZER (Direct Zero Calibration Entry)

- Press the <OK> key to start. The display will show the current weight.
- Press the <OK> key to enter the Direct Zero setting - change the mV/V setting to the correct value for Zero using the <ARROW> keys - display DONE
- Press the <OK> key to store the new zero calibration - the display will show DONE and then the weight.
- Press the <OK> key to leave the routine and return to the CAL menu - use the menu navigation to finish setup.

### 7.2.2 DIR.SPN (Direct Span Calibration Entry)

- Press the <OK> key to start - the display will show the current weight.
- Press the <OK> key - change the weight to the correct value and press the <OK> key - the display will show the current mV/V.
- Change the mV/V setting to the correct value and press the <OK> key - the display will show DONE and then the weight.
- Press the <OK> key to leave the routine and return to the CAL menu - use the menu navigation to finish setup.

## 7.3 Using Linearisation (ED.LIN)

Linearisation is used to approximate the weight output to a non-linear scale. The chart below shows a non-linear characteristic for the load cell output. From the chart, it can be seen that the trace with no linearisation applied is a poor approximation to the real characteristic. By applying one or more linearisation points, more accurate weight readings can be achieved.

To perform a linearisation, a calibration of the zero and full scale span points must have been performed. Both the zero and full scale calibration points are used in the linearisation of the scale base. These two points are assumed to be accurately set and thus have no linearisation error.

Multiple linearisation points can be set independently between zero and full scale depending on the indicator. Unused or unwanted points may also be cleared (CAL:CLR.LIN). The maximum correction that can be applied using a linearisation point is + / - 2%.

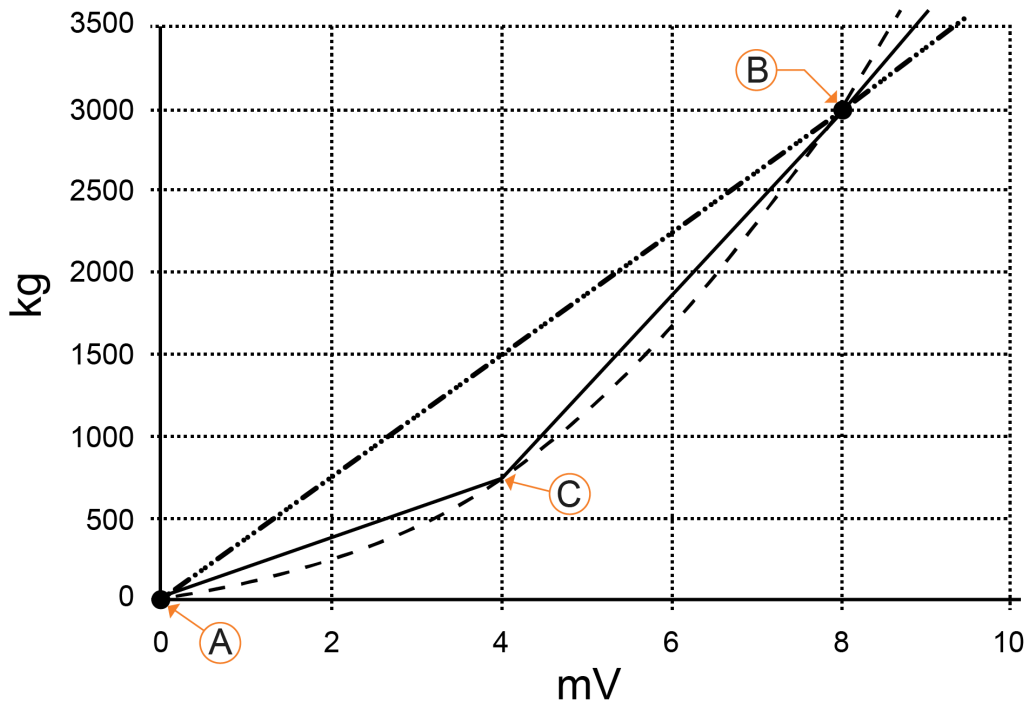

Figure 16: Non-Linear Characteristic for Load Cell Output

## 7.4 Using Gravity Compensation (GRAVITY)

To use this feature, the gravitational acceleration of the factory (G.FAC) and the installation location (G.INST) must be known. The indicator uses these 2 settings to compensate for the change in gravitational acceleration between locations.

The following procedure can be used when a scale is to be calibrated at one location and then installed at a different location.

1. Set the factory gravitational acceleration (G.FAC) to that of the location the scale is being calibrated at.
2. Perform a Zero and Span calibration. Note: When a Zero or Span calibration is performed the G.INST setting is reset to equal G.FAC.
3. Set the G.FIRST setting to ON. This enables the user prompt.

The scale can then be sent to the installation location. When the indicator is powered up the user will be prompted to enter the gravitational acceleration of their location (G.INST). At this prompt, the user can enter this setting one time only without affecting the calibration counter. Once a valid setting has been entered, the user will not be prompted again.

The G.INST setting can be edited directly in the calibration menu however this will result in the calibration counter being incremented.

---

## 8. SPECIAL FUNCTIONS (FUNC)

The instrument has special functions that can be configured on the function keys on the front panel or set up remotely. Some special functions are available as inputs (for example remote input or blanking). Special functions are configured in the FUNC setup menus where both the function key (F1,2...) and inputs (IN1,2) are listed.

Where a <FUNCTION> key is configured the associated overlay sticker (supplied) should be applied below the key. Ensure the keypad is clean and dry before affixing the sticker.

### 8.1 NONE

When set to NONE the special function key is not used during normal operation. This is the default setting.

### 8.2 TEST

Press the <TEST> key to clear the display then show all segments of the display then clear the display again before returning to normal operation.

### 8.3 HOLD

The <HOLD> key implements a manual Hold function. The Hold annunciator is active when the display is showing the held weight. Pressing the hold key again will cancel the hold. To perform the Hold function, do the following:

- Press the manual <HOLD> key once to hold the current displayed weight.
- Press the manual <HOLD> key again to return the display to normal weighing.

### 8.4 PEAK HOLD

APP:P.HOLD Peak Hold can be configured to ALWAYS or to only take a STABLE weight. With peak hold enabled the largest absolute weight, either positive or negative is stored. To view and clear the peak hold value the function P.HOLD must be assigned to a function key.

#### **P.HOLD Key: Short Press**

To use the Peak Hold function key:

- Press the <PEAK> hold key once to show the absolute peak weight reading
- Press the <PEAK> hold key again to return the display to normal weighing.

#### **P.HOLD Key: Long Press**

A long press of the <PEAK> hold key clears the peak value (note: it will immediately resample a peak value). Short press <PEAK> to return to normal weighing.

## 8.5 SINGLE

A <SINGLE> key is a manual trigger for the serial automatic transmit. A single automatic transmit string is sent when this key is pressed. This may be useful where a continual stream of serial data is not wanted.

## 8.6 Remote Key or Blanking Input

The C320, C350 and C357 allow for the inputs to be used to remotely trigger existing primary functions (ZERO, TARE, SELECT) or they can be configured as extra function keys to add new functions (HOLD, Peak HOLD etc) or a blanking function.

**Warning! The external 'keys' operate even if the instrument keys are locked and never require Operator or Setup passcodes to be entered.**

### Remote button input - existing functions (ZERO, TARE, SELECT)

Configure the INPUT (IN1, etc) for REM.KEY and select which existing function to be triggered remotely.

### Remote input - extra function

Configure the INPUT (IN1,2..) for the required function (HOLD, P.HOLD, LIVE etc). This effectively allow for extra function keys.

### Blanking input

Configure the INPUT as BLANK and select the display blanking style. Options are DASH: Fill instrument display with '-' and BLANK: completely blank instrument display. Blanking functions enable the detection of external inputs to be used to block instrument operation by blanking the screen and blocking key functions. Typical applications are for tilt sensing.

## 8.7 HI.RES

The <HI.RES> function key is used to switch the display between normal and a high resolution (x10) display of the weight. The high-resolution display is identified by flashing units.

Short Press to switch high resolution mode on and back to normal weight display.

## 8.8 TOTAL

A <TOTAL> function key allows for the accumulated total to be displayed and a long press can clear the total. The <PRINT> function is used not only to print the current weight but also to add that weight to the current total. Note accumulation must be ON within the setup for this key to have effect.



**Short Press:**

- When the <TOTAL> key is pressed the indicator displays count (n) followed by the accumulated weight/pieces.
- Depending on the units/pieces setup, the sequence of the total for each unit and pieces will scroll through
- The TOT annunciator is displayed during this sequence

**Long Press:**

- A long press will display CLEAR
- Press <OK> to clear the total, otherwise <CANCEL>

A long press of the <PRINT> key causes the total accumulated weight to be printed and then cleared.

**8.9 PRINT**

A <PRINT> function key triggers print events with the chosen format on the selected serial output. Weight will accumulate after each print only if accumulation/totals is on in the setup. (examples below assume date/time is available)

**Short Press:**

- The <PRINT> will trigger an output of the current weight reading.

```
000048 06/05/2023 15:10
      121.4 kg G
      43.5 kg N
      77.9 kg T
```

- Each time the <PRINT> key is pressed the weight is automatically added to an internal accumulated/total weight. (Note: the total weight can be displayed by configuring a <TOTAL> function key)

```
000048 06/05/2023 15:10
      120.0 kg G
      0.0 kg N
      0.0 kg T
000049 06/05/2023 15:11
      100.0 kg G
```

```
0.0 kg N
0.0 kg T
000050 06/05/2023 15:15
110.0 kg G
0.0 kg N
0.0 kg T
```

**Long Press:**

- A long press of the <PRINT> key will print the total. Note totals will be cleared and sequence number is not cleared.

```
000048 06/05/2023 15:10
120.0 kg G
0.0 kg N
0.0 kg T
000049 06/05/2023 15:11
100.0 kg G
0.0 kg N
0.0 kg T
000050 06/05/2023 15:15
110.0 kg G
0.0 kg N
0.0 kg T
ITEMS: 3
TOTAL: 330.0 kg
```

- When Docket printing, a long press ends the docket.

**COUNTING Active:**

If counting is active, the printout has a fifth line for the counting information (p for pieces):

```
000048 06/05/2023 15:10
      121.4 kg G
      43.5 kg N
      77.9 kg T
      132 p
```

Whenever a new sample is taken when counting, the instrument prints the sample:

```
SAMPLE: 100 p = 1.0 kg
```

Example print format when counting is active and long press of <PRINT> key to print total number of items, weight and quantity. Note totals will be cleared and sequence number is not cleared.

```
000048 06/05/2023 15:10
      120.0 kg G
      6.0 p
000049 06/05/2023 15:11
      100.0 kg G
      5.0 p
000050 06/05/2023 15:15
      80.0 kg G
      4.0 p
ITEMS:      3
TOTAL:     300.0 kg
QTY:      15 p
```

## 8.10 TARGET

The <TARGET> key long press is used to view and edit the setpoint threshold values.

### Long Press:

- display will show first set point name followed by its output target.
- <OK> to enter edit mode and use the <ARROW> keys to edit the setpoint target.

- <OK> to save changes and display the next setpoint if there is one configured, repeat above to modify that set point target.
- Or to go directly to view the next set point use the <UP ARROW>
- <CANCEL> to exit the targets or up arrow to move to the next set point.

## 8.11 UNITS

The units key is used to convert primary (calibrated) unit to alternative units (2 secondary units available).

**Short Press:** to step through and display up to three units as per setup.

**Long Press:** When piece counting is enabled (using P.COUNT setting) pieces (p) is one of the available units and the long press varies. When there is no piece counting, a long press has no function.

### P.COUNT : WEIGHT

**Long Press:** display will show ENTER QTY and then move to editor to allow the number of piece to be entered. Use <ARROWS> keys to adjust the quantity. <OK> to exit and save and <CANCEL> to not save change.

### P.COUNT : RESAMP

**Long Press:** to start the resample routine.

- ENTER QTY will display and then move to editor to allow the number of piece to be entered. <OK> to save the quantity and finish this step.
- RESAMP QTY will display
- Add more pieces, the indicator recalculate the count and double beep for a successful resample (repeat as required) and display the number of pieces (p)
- If the resample was unsuccessful a long beep will sound and the new value will be discarded.
- <OK> finish the routine.

## 8.12 LIVE

The <LIVE> key is used to enable live weight averaging. With this feature it is possible to determine the weight of a continually moving mass (e.g. livestock).

**Short Press:** to start live weigh sequence, the Hold (H) annunciator will flash.

- Move animal onto scale
- The instrument begins to calculate a long-term average that compensates for any movement in the animal.
  - Retrigger percentage: during the weighing process a movement in weight by more than the retrigger percentage will cause the weighing average to be restarted.

- Tolerance: sets the overall percentage of readings discarded from the final average. Where 30% is 15% low samples and 15% high samples
- Delay: is the time after the threshold is exceeded before average starts capturing readings. This allows time for the animal to fully enter the scale area.
- The indicator will display TIME OUT if it was unable to secure a reading given the above parameters
- The Hold (H) annunciator is steady when the final sample weight is shown on the display.

**Short press:** to restart sequence

**Long Press:** to stop the live weigh function

## 9. SERIAL OUTPUTS (SERIAL)

The instrument supports **up to three** bi-directional RS-232 output and temporary rinLINK connection, allowing for a number of serial output types for communications with external devices such as printers, computers, PLCs, or remote displays. Refer to Optical Communications<sup>[9]</sup> page. For wiring connections and pinouts, refer to Serial Port 1 & 2 Connections<sup>[6]</sup> page. Serial communications are supported in different firmware variant.

The instrument computer communications can range from simple automatic streamed output, through to a command-response system. In addition to the rinLINK, the instrument can be programmed and calibrated via the RS-232 serial port. The calibration counter is incremented when the calibration related steps are accessed via RS-232, the serial port or the rinLINK. This means that calibration via the serial port or rinLINK cannot be carried out without affecting the certification of a trade installation.

### 9.1 Network rinCMD (RINCMD)

The rinCMD network protocol, formally known as Protocol B, uses ASCII characters with a single master POLL / RESPONSE message structure. All information and services are provided by registers each of which has its own register address.

#### 9.1.1 Basic Message Format

The basic message format is as follows:

<b>ADDR</b>	<b>CMD</b>	<b>REG</b>	<b>:DATA</b>	↵
-------------	------------	------------	--------------	---

ADDR is a two character hexadecimal field corresponding with the following:

ADDR	Field Name	Description
80 <sub>H</sub>	Response	'0' for messages sent from the master (POLL). '1' for messages received from an instrument (RESPONSE)
40 <sub>H</sub>	Error	Set to indicate that the data in this message is an error code and not a normal response.
20 <sub>H</sub>	Reply Required	Set by the master to indicate that a reply to this message is required by any slave that it is addressed to. If not set, the slave should silently perform the command.
00 <sub>H</sub> .. 1F <sub>H</sub>	Indicator Address	Valid instrument addresses are 01 <sub>H</sub> to 1F <sub>H</sub> (1 .. 31). 00 <sub>H</sub> is the broadcast address. All slaves must process broadcast commands. When replying to broadcasts, slaves reply with their own address in this field.

CMD is a two character hexadecimal field:

CMD	Command	Description
05 <sub>H</sub>	Read Literal	Read register contents in a 'human readable' format
11 <sub>H</sub>	Read Final	Read register contents in a hexadecimal data format
16 <sub>H</sub>	Read Final (Decimal)	Same as Read Final except numbers are decimal.
12 <sub>H</sub>	Write Final	Write the DATA field to the register.
17 <sub>H</sub>	Write Final (Decimal)	Same as Write Final except numbers are decimal.
10 <sub>H</sub>	Execute	Execute function defined by the register using parameters supplied in the DATA field.

REG	is a four character hexadecimal field that defines the address of the Register specified in the message. The viewer software will show the register address for each setting in the menu structure when they are accessed.
: DATA	carries the information for the message. Some messages require no DATA (eg Read Commands) so the field is optional. When a DATA field is used a ':' (COLON) character is used to separate the header (ADDR CMD REG) and DATA information.
8	is the message termination (CR LF or ";" ).

Note: The hexadecimal codes are combined in the fields described above when multiple options are active at the same time. For example an error response message from instrument address 5 would have an ADDR code of C5<sub>H</sub> (80<sub>H</sub> + 40<sub>H</sub> + 05<sub>H</sub>).

### 9.1.2 Termination

Message termination is possible in two ways.

- For normal communications that do not involve checksums use either a CRLF (ASCII 13, ASCII 10) as a terminator or a semicolon (;' ASCII ). There is no start-of-message delimiter.
- To use a checksum the message is framed as:

**SOH <Message> CRC EOT**

SOH	ASCII 01
CRC	a 4 character hexadecimal field comprising the 16 bit CRC checksum. The CRC uses the 16 bit CCITT polynomial calculation and includes only the contents of the <Message> section of the transmission.
EOT	ASCII 04

### 9.1.3 Error Handling

If a command cannot be processed, the indicator returns an error. The ERROR bit in the ADDR field is set and the DATA field contains the Error Code as follows:

Error	DATA	Description
Unknown Error	C000 <sub>H</sub>	Error is of unknown type
Not Implemented Error	A000 <sub>H</sub>	Feature not implemented on this device
Access Denied	9000 <sub>H</sub>	Passcode required to access this register
Data Under Range	8800 <sub>H</sub>	Data too low for this register
Data Over Range	8400 <sub>H</sub>	Data too high for this register
Illegal Value	8200 <sub>H</sub>	Data not compatible with this register
Illegal Operation	8100 <sub>H</sub>	CMD field unknown
Bad parameter	8040 <sub>H</sub>	Parameter not valid for this execute register
Menu in Use	8020 <sub>H</sub>	Cannot modify register values while SETUP menus are active
Viewer Mode required	8010 <sub>H</sub>	Advanced operation chosen which requires the instrument to be in viewer mode.
Checksum required	8008 <sub>H</sub>	A checksum is required for the chosen command.

### 9.1.4 Ring Network

Instruments can be configured in a Ring Network which requires the central computer to send additional framing characters, 'Echo-On' (= <DC2> =ASCII 12<sub>H</sub>) and 'Echo-Off' (= <DC4> =ASCII 14<sub>H</sub>) around each command. Below is an example Ring Network command and response with two indicators:

COMMAND	RESPONSE
<DC2>20110150:<CR><LK<DC2>20110150:<CR><LF>	
<DC4>	81110150:07/01/2030 17-29<CR><LF>
	82110150:07/01/2030 17-30<CR><LF>
	<DC4>

### 9.1.5 rinCMD Examples

	Description
<b>Read Gross Weight ( Read Final)</b>	<b>COMMAND:</b> Read Gross Weight (Register 0026): ADDR = 20 <sub>H</sub> : Reply required from any instrument CMD = 11 <sub>H</sub> : Read Final REG = 0026 <sub>H</sub> : Gross Weight



<b>COMMAND:</b> 20110026 ↵ <b>RESPONSE:</b> 81110026:00000064↵	<b>RESPONSE:</b> Response is from instrument #1 which currently has a Gross weight of 64 <sub>H</sub> = 100 kg.
<b>Read Gross Weight (Read Literal)</b>	<b>COMMAND:</b> Read Gross Weight (Register 0026 <sub>H</sub> ): ADDR = 20 <sub>H</sub> : Reply required from any instrument CMD = 05 <sub>H</sub> : Read Literal REG = 0026 <sub>H</sub> : Gross Weight <b>RESPONSE:</b> Same response from instrument #1 but in literal format.
<b>COMMAND:</b> 20050026↵ <b>RESPONSE:</b> 81050026: 100 kg G↵	
<b>Set Print Header (Write Final, Execute)</b>	<b>COMMAND A:</b> Write Print Header String (Register A381 <sub>H</sub> ) ADDR = 21 <sub>H</sub> : Reply required from instrument #1 CMD = 12 <sub>H</sub> : Write Final REG = A381 <sub>H</sub> : Print Header String DATA = 'Hello There' <b>RESPONSE A:</b> Instrument #1 reports "ERROR: Access Denied". (Writing to this register requires a passcode) <b>COMMAND B:</b> Enter SAFE SETUP Passcode (Register 1A <sub>H</sub> ) ADDR = 21 <sub>H</sub> : Reply required from instrument #1 CMD = 12 <sub>H</sub> : Write Final REG = 1A <sub>H</sub> : Enter SAFE PASSCODE DATA = 4D2 <sub>H</sub> (passcode is 1234) <b>RESPONSE B:</b> Instrument #1 reports Passcode Accepted <b>COMMAND C: (resend COMMAND A).</b> <b>RESPONSE C:</b> Instrument #1 reports "Command Successful". <b>COMMAND D:</b> Save Settings (Register 10 <sub>H</sub> ) ADDR = 21 <sub>H</sub> : Reply required from instrument #1 CMD = 10 <sub>H</sub> : Execute REG = 10 <sub>H</sub> : Save Settings <b>RESPONSE D:</b> Instrument #1 reports "Command Successful".
<b>COMMAND A:</b> 2112A381:Hello There↵ <b>RESPONSE A:</b> C112A381:9000↵  <b>COMMAND B:</b> 2112001A:4D2↵ <b>RESPONSE B:</b> 8112001A:0000↵  <b>COMMAND C:</b> 2112A381:Hello There↵ <b>RESPONSE C:</b> 8112A381:0000↵  <b>COMMAND D:</b> 21100010↵ <b>RESPONSE D:</b> 81100010:0000↵	
<b>Trigger Zero Button Press (Write Final)</b>	<b>Description</b> <b>COMMAND A:</b> Send down the Zero button key code. <b>RESPONSE A:</b>

<b>COMMAND A:</b> 21120008:0B↵ <b>RESPONSE A:</b> 81120008:0000↵ <b>COMMAND B:</b> 21120008:8E↵ <b>RESPONSE B:</b> 81120008:0000↵	Instrument #1 reports "Command Successful".  <b>COMMAND B:</b> Do a long press of the F1 key. <b>RESPONSE B:</b> Instrument #1 reports "Command Successful".
<b>Streaming (Write Final, Read Final, Execute)</b>	<b>COMMAND A:</b> Setup to read the displayed weight. <b>RESPONSE A:</b> Instrument #1 reports "Command Successful".  <b>COMMAND B:</b> Setup to read the IO status. <b>RESPONSE B:</b> Instrument #1 reports "Command Successful".  <b>COMMAND C:</b> Read the combined data. <b>RESPONSE C:</b> Data is concatenated. It is 8 hexadecimal digits each.  <b>COMMAND D:</b> Set streaming to 3Hz. <b>RESPONSE D:</b> Instrument #1 reports "Command Successful".  <b>COMMAND E:</b> Start the automatic streaming. <b>RESPONSE E:</b> Instrument #1 reports "Command Successful" followed by streamed data at 3Hz.  <b>COMMAND G:</b> Stop the automatic streaming. <b>RESPONSE G:</b> Instrument #1 reports "Command Successful".
<b>COMMAND A:</b> 21120042:06↵ <b>RESPONSE A:</b> 81120042:0000↵ <b>COMMAND B:</b> 21120043:11↵ <b>RESPONSE B:</b> 81120043:0000↵ <b>COMMAND C:</b> 21110040↵ <b>RESPONSE C:</b> 81110040:000005DB00000 009↵ <b>COMMAND D:</b> 21120041:03↵ <b>RESPONSE D:</b> 81120041:0000↵ <b>COMMAND E:</b> 21100040:1↵ <b>RESPONSE E:</b> 81100040:00000000↵ 81110040:000005DB00000 009↵ 81110040:000005DB00000 009↵ <b>COMMAND G:</b> 21100040:0↵ <b>RESPONSE G:</b> 81100040:00000000↵	

## 9.2 Network Protocol SIMPLE (SIMPLE)

The simple network protocol allows the indicator to respond to common simple ASCII key press commands and enable the indicator to be used in legacy systems.

The response setting (RESP) defines if there is any response sent to successful commands. A setting of OK will send OK<CR> on successful receipt of command or ??<CR> if the command is not understood.

Function	Simple commands
Zero Key	Z<CR>, %z, \FAh, KZERO<CR>, MZ<CR>, m<CR>, KZ
Tare Key	T<CR>, %t, \F4h, KTARE<CR>, MT<CR>, t<CR>, KT
Gross/Net Key	%s, \F3h, KGROSSNET<CR>, KG00<CR>(*)
To Gross	G<CR>, 0%s, KGROSS<CR>, MG<CR>, C<CR>, r, @00
To Net	N<CR>, 1%s, KNET<CR>, MN<CR>, n<CR>, @00CNET<C
Print Key	%p, \F0h, KPRINT<CR>, KP00<CR>(*)
Single	P<CR>, W<CR>, \05h, \95h, \96h, S<CR>, H<CR>,
0..9 Keys	0, 1, 2, 3, 4, 5, 6, 7, 8, 9, ., K0<CR>,
OK Key	%e, \E5h, \0Dh, KENTER<CR>
Cancel Key	\1Bh

\* 00 is the broadcast address, this can be changed to an individual instruments address.

### 9.3 Network REMOTE (REMOTE)

By configuring the Serial Output to REMOTE the option exists to make a C3 unit into a full mimic of another C3 connected to a scale. The instruments are connected by a simple crossover cable as shown. As a remote mimic (MIMIC), indicator #1 is connected to the scale (scale) and another indicator #2 (remote C3) is configured as the remote unit.

Set as TYPE:REMOTE, then options are for the REM.TYP to be:

- MIMIC: Applicable when both units are C3. As the units fully match the remote C3 has full operator functionality back to the scale unit. In this case remote C3 is a full copy of scale C3, including backlight colour and all keys work same whether pressed remotely or on the main instrument.
- REM.M: Operates in a similar manner to MIMIC except that the scale unit is not a C3 but another Rinstrum indicator. The remote C3 asks for weight and status only. In this case the remote C3 may not be a perfect copy of the main scale and not all scale keys may be supported. This mode provides basic support for displayed weight, units, primary annunciators like motion and CofZ and the main keys like Zero, Tare etc.
- REM.S: The remote C3 behaves like a remote display and is listening for an auto out sent from the scale unit.

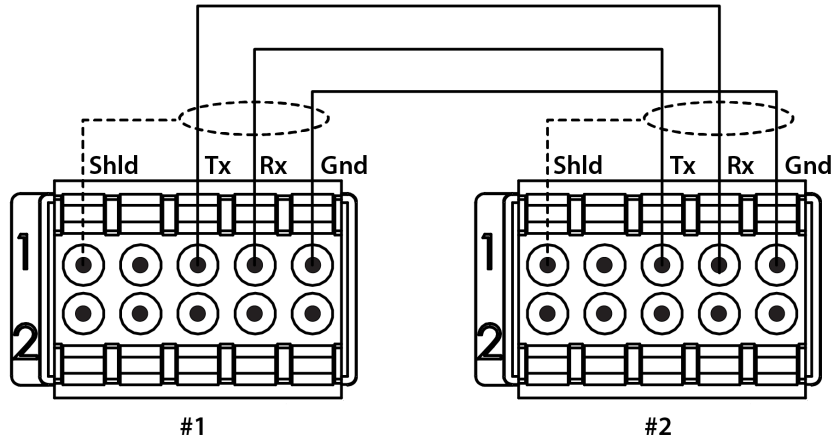

Figure 17: Connection Diagram for Network Remote mode

### 9.4 Automatic Weight Output (SER.AUT)

The automatic output is normally used to drive remote displays, a dedicated computer, or PLC communications. It is configured using the SER.AUT menu. Any serial port can be used.

Transmission Speed: The rate of transmission is set by the AUT.SPD setting. 1 - 10Hz and FULL (25Hz) send unsolicited messages whereas SINGLE only sends messages when a SINGLE input is received from an external input. This enables external systems like PLCs to synchronise the AUTO output to their requirements.

Source: The data source can be set to use either the primary unit or the displayed unit.

#### 9.4.1 Auto Weight Format String

Format	Description
FMT.A	<STX> <SIGN> <WEIGHT (7)> <STATUS> <ETX>
FMT.B	<STX> <S0> <SIGN> <WEIGHT (7)> <UNITS (3)> <ETX>
FMT.C	<STX> <SIGN> <WEIGHT (7)> <S1> <S2> <S3> <S4> <UNITS (3)> <ETX>
FMT.D	<STX> <SIGN> <WEIGHT (7)> <ETX>
FMT.E	<STX> <SIGN> <WEIGHT (7)> <S5> <UNITS (3)> <MODE (4)> <ETX>
CUSTOM	As per contends of the EV.AUTO token string.
FMT.F	<STX> <SIGN> <WEIGHT (7)> <UNITS> <S1> <S2> <CR> <LF>
FMT.G	<STX> <SIGN> <WEIGHT (7)> <S1> <S2> <S3> <S4> <UNITS (3)> <ETX>
FMT.H	<STX>< WEIGHT (8)>< GROSS (G, N)>< MOTION (M, S)>< OVERLOAD (I, O, U)>
FMT.I	<STATUS (OL, ST, US)><GROSS (GR, NT)>< SIGN>< WEIGHT (7)>< UNITS (2)>

STX	Start of transmission character (ASCII 02).
ETX	End of transmission character (ASCII 03)
SIGN(Except FMT.G)	The sign of the weight reading (space for positive, dash (-) for negative).

SIGN(FMT.G)	The sign of the weight reading and serial traffic light control. Both the sign character and traffic lights can be displayed at the same time. Setpoint 1 is mapped to the red light and setpoint 2 is mapped to the green light. 0x20 = No Sign or Traffic light    0x2D = '-' Sign 0x30 = RED                            0x3D = Red and '-' Sign 0x60 = GREEN                        0x6D = GREEN and '-' Sign 0x70 = RED + GREEN                0x7D = RED + GREEN and '-' Sign e.g. 0x60 will display a Green but no negative sign 0x6D will display both the Green and the negative sign
WEIGHT(7)	A seven-character string containing the current weight including the decimal point. If there is no decimal point, then the first character is a space. Leading zero blanking applies.
S0	Provides information on the weight reading. The characters G/N/U/O/M/E represent Gross / Net / Underload / Overload / Motion / Error, respectively.
UNITS(3)	A three-character string, the first character being a space, followed by the actual units (e.g. ^kg or ^^t). If the weight reading is not stable, the unit string is sent as ^^ ^.
S1	Displays G/N/U/O/E representing Gross / Net / Underload / Overload / Error,
S2	Displays M/^ representing Motion / Stable, respectively.
S3	Displays Z/^ representing centre of Zero / Non-Zero, respectively.
S4	Displays - representing single range.
S5	Displays " /m"/c" representing Stable / Motion / Overload or Underload
Mode	Displays "_g_" or "_n_" for gross or net weight.
'ADDR CMD REG	DATA'
SP	Space character, " "
CONSEC	Consecutive print ID
DATE, TIME	Date and time.
TRACE	Traceable displayed weight.

## 9.5 Printing (PRINT)

The instrument can have up to two (2) printouts. There are two (2) types of printout:

- RECORD: Record printouts are essentially a single printout generated by a single print event.
- DOCKET: Docket printouts are comprised typically of the output of a number of print events. There is a start section that includes header information, followed by a number of transactions and finally the end of the docket including sub-total information etc.

There are two different fixed formats for each printout type defined in the instrument. The format of these printouts is shown in the following sections.

For custom printing each print event has an associated token string which includes literal ASCII text along with special token characters that are expanded at the time of printing to fields like weight, time and date.

### 9.5.1 Print ID

A unique Consecutive Print ID appears on record printouts. It cannot be cleared and increments for every traceable weight reading.

### 9.5.2 Record Printouts

Format	Example
<b>FMT.A</b>	000000057 15/09/23 12:20:23 750kg G
<b>FMT.B</b>	Joe's Fruit & Veg 30 Yarmouth Pde Tamworth NSW 2040 01/01/2003 11:30 ID: 000000058 T: 5.0 kg G: 100.4 kg N: 95.4 kg Thank You!
<b>CUSTOM</b>	Format defined by REC.PRN token string.

Action	Event	Event Description
Print Key	REC.PRN	Defines what is printed when the print key is pressed

### 9.5.3 Docket Printouts

Format	Example
<b>FMT.A</b>	Joe's Fruit & Veg 30 Yarmouth Pde Tamworth NSW 2040 13/03/03 11:09:27 4.06 kg, 5.04 kg, 3.15 kg, 5.02 kg, 4.48 kg, 6.15 kg, Total 27.90 kg Items 6 Thank You!
<b>FMT.B</b>	Joe's Fruit & Veg 30 Yarmouth Pde Tamworth NSW 2040 13/03/03 11:09:27 4.06 kg 5.04 kg 3.15 kg 5.02 kg 4.48 kg

	6.15 kg Total 27.90 kg Items 6 Thank You!
<b>CUSTOM</b>	EV.D.NEW PRN.KEY EV.D.END

Custom Docket Events and associated operator actions

Action	Event	Event Description
Print Key	EV.D.NEW	Event Docket New - controls the first part of the docket that is printed along with the first transaction.
Print Key	PRN.KEY	Event Print - controls the format of each transaction on the docket.
Long Press Print Key	EV.D.END	Event Docket End - controls the format of the end of the docket including printing sub-totals etc.

### 9.5.4 Custom Printing

A print docket is built up from multiple print passes. Each of the print passes is defined by a specific configuration string. Print passes are triggered by operator events – these include short and long press of the Print key.

The content of the configuration string for each event includes direct text (the word “Weight” to be placed near the current weight for example) and control characters called ‘Tokens’. Tokens are used to specify where the instrument data fields are to be inserted.

Tokens are characters outside the normal printable range. Each token character is represented by a three character escape sequence consisting of a ‘\’ followed by two hex characters or by a three digit decimal ASCII number. When entering tokens via the instrument keys the decimal ASCII code is used. When entering tokens using the viewer software the escape sequence is used. Examples of tokens:

```

\D7 (ASCII 215) = current displayed weight
\BF (ASCII 191) = date
\C0 (ASCII 192) = time

```

A simple custom format string might be:

```
'Weight: \D7\C1'
```

To produce Weight: 30.0kg ^ when the print key is pressed.

Events are triggered by short and long press of the Print key and changing products as listed as listed in the tables for each type.

## 10. SETPOINTS (SETP)

The C3 series has 8 setpoints with setpoints 1 and 2 linked to the onboard digital outputs. Setpoint status can be used to drive the onboard outputs directly, sound the buzzer, change display background colour, or can be transferred to external control systems using Modbus RTU or through field bus expansion.

Setpoint functions include,

- OVER/UNDER target
- CHECKWEIGH : OVER/ UNDER/ PASS
- Status (motion, zero,net etc)
- Weigh In and Weigh Out

Setpoint outputs can be latched and reset from remote inputs or external control.

### 10.1 Common Settings

There are a number of settings that are common to all setpoint types.

**LOGIC:** This setting determines whether the output is normally on or normally off. Logic HIGH means the output follows the activity of the setpoint and is on when the setpoint conditions are met. Logic LOW reverses the operation of the output.

For example: Consider a Center-of-Zero status setpoint. This type of setpoint is active when the Centre-of-Zero annunciator is lit. With logic HIGH an output would turn on whenever the Centre-of-Zero annunciator was lit. With logic LOW the output would turn off when the Centre-of-Zero annunciator is lit and remain on otherwise.

Note that the outputs revert to the off state when the instrument SETUP menus are active or if FUNC.EN feature suspends automated functions.

**ALARM:** Select what alarm response is triggered when the setpoint is active. SINGLE sounds a single beep every two seconds, DOUBLE sounds a double beep every two seconds and FLASH flashes the instrument display. Note that the Alarm conditions are not influenced by the LOGIC setting, i.e. they follow the activity of the setpoint regardless of the physical state of the output.

**TIMING:** Select the output timing of the setpoint. The following examples are explained in the context of an OVER setpoint however the timing options are available for all setpoint types.

Options are:

- LEVEL: the setpoint is active whenever the weight has gone over the target, has not dropped below the hysteresis value and the reset input is not currently active.
- EDGE: The setpoint only becomes active when the weight crosses over the target. The setpoint becomes inactive when the weight goes below the hysteresis value or the reset input becomes active.
- LATCH: The setpoint becomes active when the weight goes over the target. The setpoint becomes inactive when the reset input becomes active.

**RESET:** Select which input is used to disable the setpoint.



**NAME:** Name the setpoint. This will be shown when editing targets for OVER or UNDER type setpoints.

**BACKLIGHT:** This sets the backlight colour to be used when the condition of the setpoint is met. This for example could be high or low from the setpoint target itself or directly from the checkweigh engine using a status based setpoint.

### 10.2 Weigh in (OVER) Setpoints and Weigh Out (UNDER) Setpoints

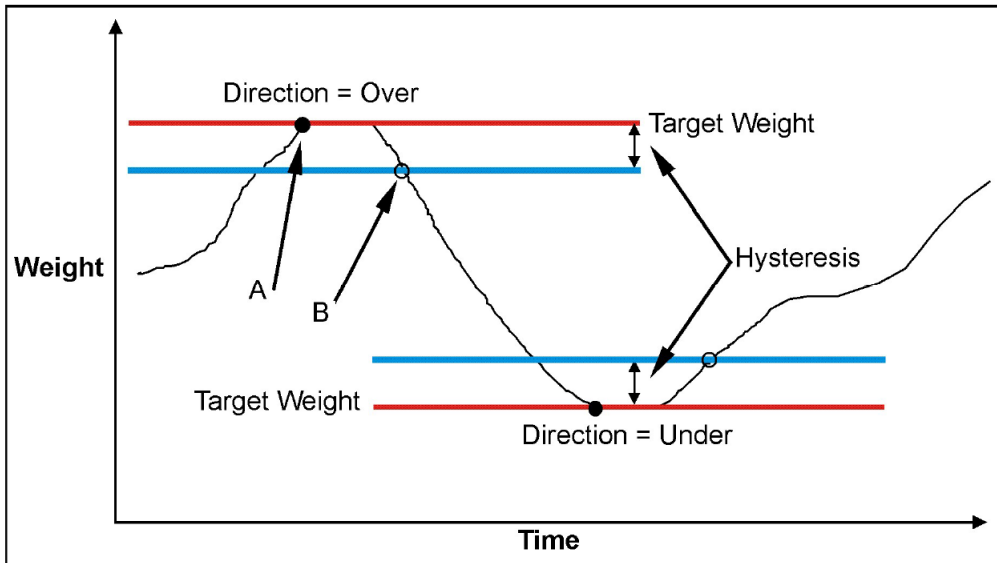

Figure 18: Weigh In and Weigh out Setpoints

LOGIC	Point A	Point B
HIGH	ON	OFF
LOW	OFF	ON

**TARGET:** This is the target value for output X. This target provides the threshold value when the OVER or UNDER type options are selected.

**Hysteresis (HYS):** This setting determines the change in weight required for an active setpoint to become inactive again. A value of zero still leaves 0.5 graduations of hysteresis.

**SOURCE:** Select the weight source for the setpoint to use. Options are:

- GROSS uses gross weight only
- NET uses net weight only
- 'GR or NT' uses either gross or net depending on which is currently displayed.
- PIECE uses gross or net piece count depending on which is currently displayed.

### 10.3 OVER Setpoint Timing Options

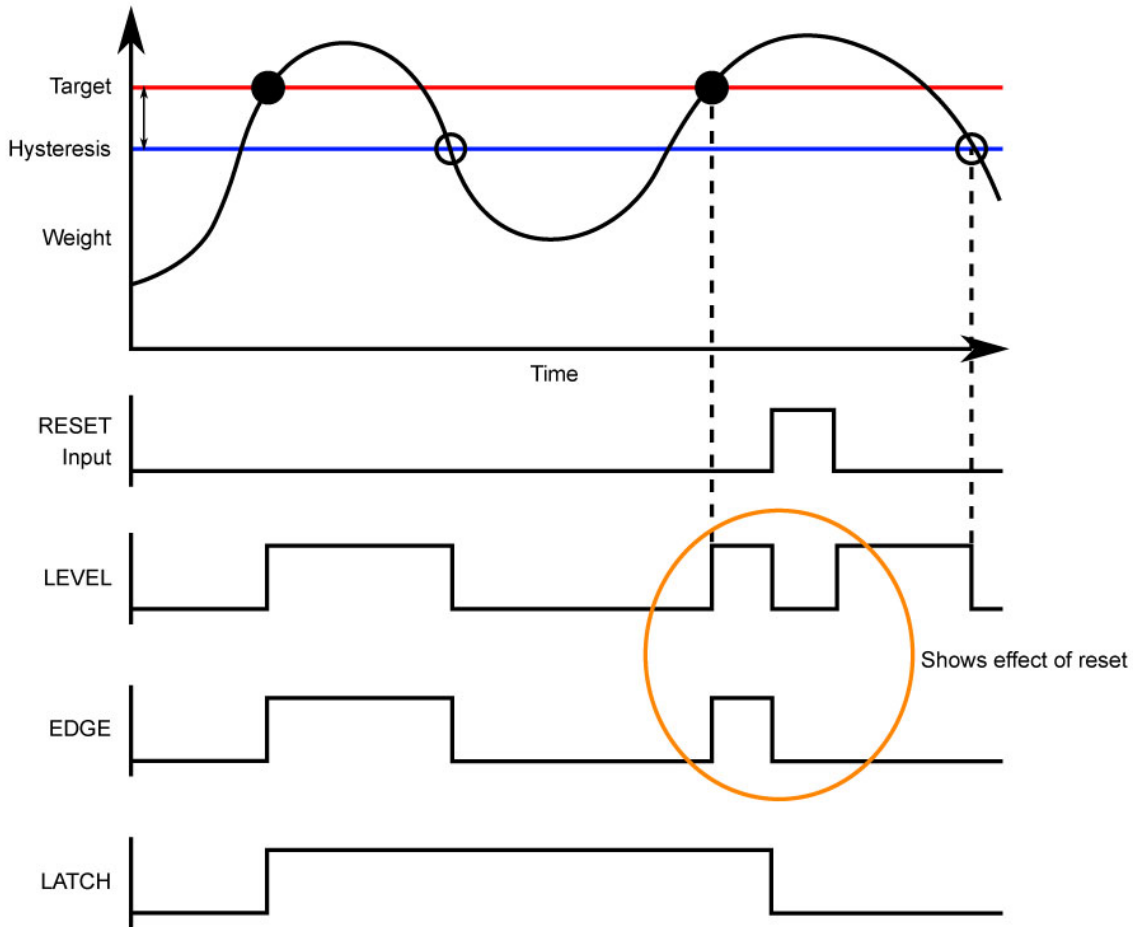

Figure 19: Over Setpoints Timing Diagram

### 10.4 Status based Setpoint Types

The following setpoint TYPES are all based on the status of the instrument.

- OFF: Setpoint is always inactive.
- ON: Setpoint is always active. This type of setpoint is useful to show that the instrument is running.
- Centre of Zero (COZ): Setpoint is active when COZ annunciator is lit.
- ZERO: Setpoint is active when the weight is within the Zero Band setting.
- SOURCE: The ZERO setpoint also has a SOURCE setting to determine if the zero condition is based on the gross or net reading. The GR.or.NT option uses the currently selected weight (gross or net).
- NET: Setpoint is active when the NET annunciator is lit.
- MOTION: Setpoint is active when the MOTION annunciator is lit.

- ERROR: Setpoint is active when the instrument detects any error condition signified by the display of Exxxx on the primary display.
- BUZZER: Setpoint is active when the buzzer beeps.
- C.W.HI, C.W.OK, C.W.LO : A setpoint will follow these check weigh status returned from the checkweigh engine. Associated annunciator is displayed also.
- W.IN: Setpoint is active till target weight is reached. Weight should be incremented till the target value is reached. (ex: Filling a tank)
- W.OUT: Setpoint is active till target weight is reached. Weight should be decremented till the target value is reached. (ex: Draining a tank)

## 11. LICENSING

If you are using a fully licensed unit (ie activated from factory) then this section can be ignored. There may however be situations where license codes are used to activate the indicator software in the field. License codes are unique for each indicator and firmware can be purchased from Rinstrum or directly through rinLIVE.

### 11.1 Unlicensed Software

If indicator has not yet been licensed (activated), the message “ENTER” “LICENC” will be displayed on start up. The indicator can't be put into service until it is activated by entering the license code.

To allow temporary use of the indicator for testing purposes, license entry can be skipped by pressing the <TARE> key. The indicator will operate for 5 minutes before returning to a license entry prompt. From this point on the indicator will remain in the license entry prompt indefinitely until a valid license code is entered.

### 11.2 Licence Code Entry from Keypad

To license a C3, at the “P.CODE?” prompt:

- Press the ZERO key to continue. The display will show “000000” with the blinking cursor at the left most digit.
- Use the <ARROW> keys to edit each digit according to the license (note: the license is specific for that firmware and that unit serial number)

Once the cursor has been moved past the last digit, the entered code will be checked. If successful the indicator will prompt “OK” and the indicator will continue to normal operation. If the entered code is not valid, the indicator will prompt “FAILED” and either continue to the 5 minute test described above, or return to the license entry prompt if the 5 minute test has already been run.

## 12. UPGRADING FIRMWARE

C3 Series indicator firmware are field upgradable.

### 12.1 Upgrade using flash programming executable

**Warning: If the indicator firmware is upgraded the calibration counter may be incremented if the upgrade is major firmware release (ie: V1.xx to V2.xx).**

**In these major upgrades, there is a risk that configuration setting of the old version may reset to new defaults. It's recommended to save configurations using the C3 viewer.**

Follow the instructions below to upgrade the indicator firmware:

1. On a Windows PC, run the flash programming executable, usually named C300-5xx-<version>-M02.exe (eg: C300-500-0.2.2-M02.exe).

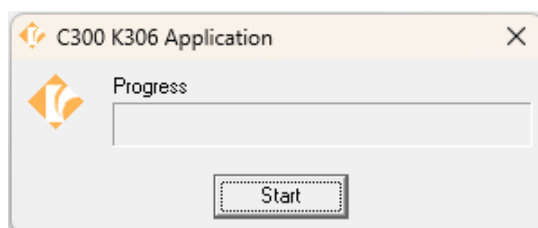

2. Connect rinLINK cable to a USB port on the PC and optical port on the front of the C3 indicator.
3. Power up the indicator.
4. Click "Start" on the flash programming software.
5. Select the serial port for the USB optical cable and click Ok.

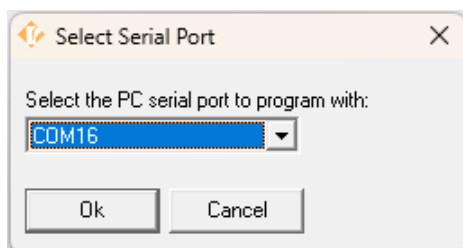

- Click “Next >>>”

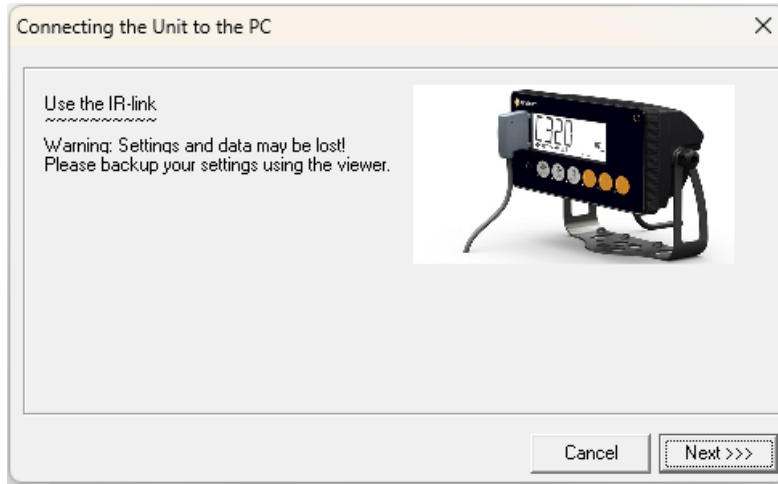

- The flash programming software will display “Connecting” If this step fails, try Upgrade in boot mode<sup>74</sup>.

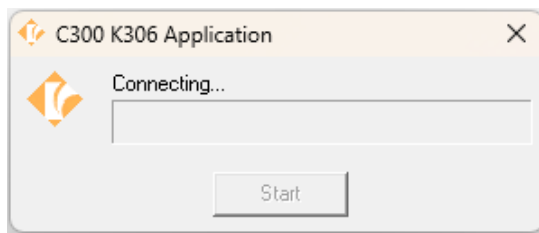

- The indicator will display “PROG”, and programming software will first program, and then verify the new firmware.

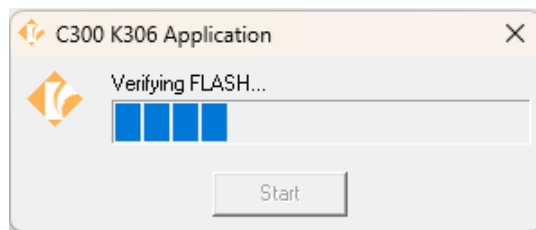
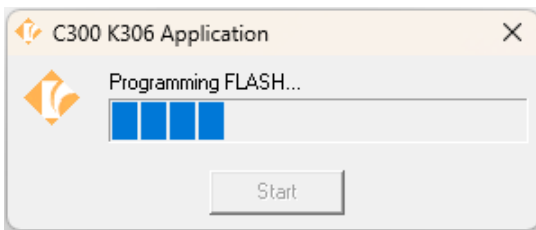

- The indicator will restart running the new firmware, and the programming software will display the following:

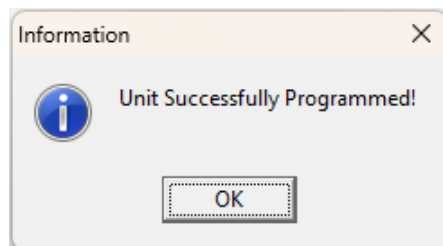

## 12.2 Upgrade in boot mode

If connecting using the instructions above failed with the “User Connect Method Failed” message, then use the boot mode instructions detailed below.

1. On a Windows PC, run the flash programming executable, usually named C300-5xx-<version>-M02.exe (eg C300-500-0.2.2-M02.exe).

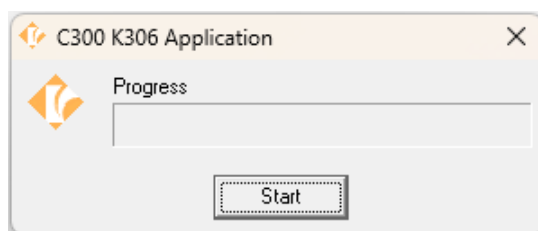

2. Connect rinLINK cable to a USB port on the PC and optical port on the front of the C3 indicator.

3. Power up the indicator.

4. Click “Start” on the flash programming software.

5. Select the serial port for the USB optical cable and click Ok.

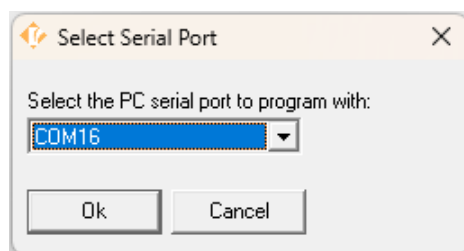

6. Click “Next >>>”

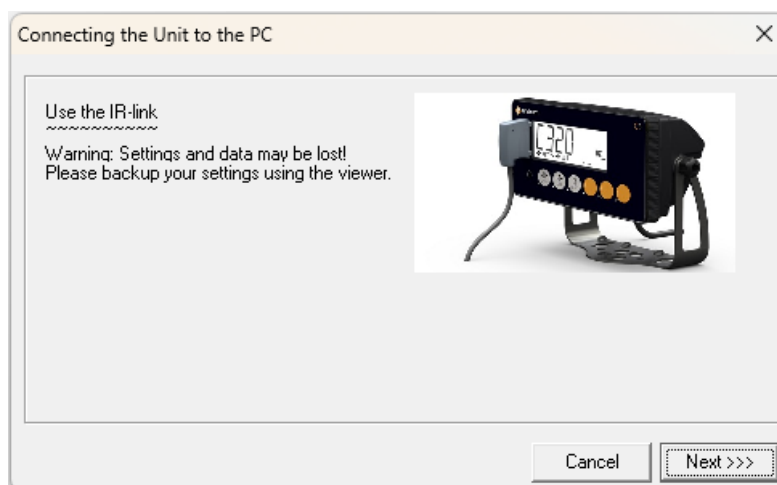

6. The flash programming software will display “Connecting”. This will fail.

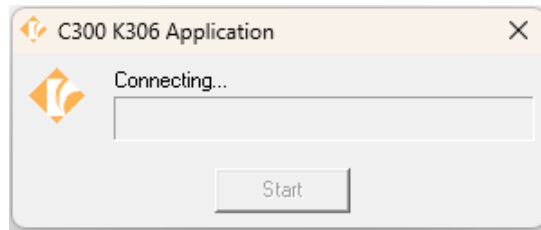

7. To begin boot mode programming, remove the power from the indicator and click “OK”.

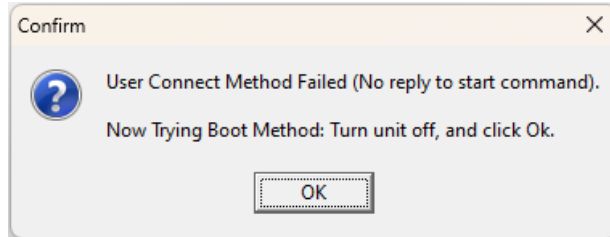

8. When this dialog appears, apply power to the indicator.

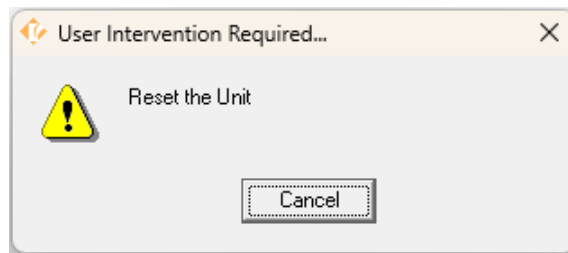

8. The indicator will display “PROG”, and programming software will first program, and then verify the new firmware.

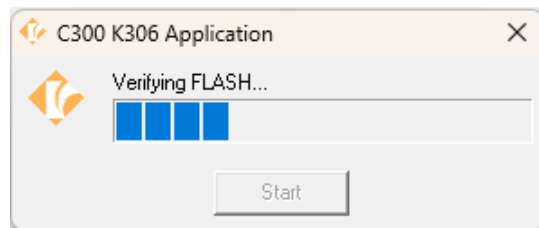
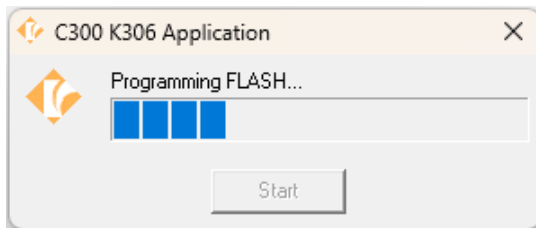

9. The indicator will restart running the new firmware, and the programming software will display the following:

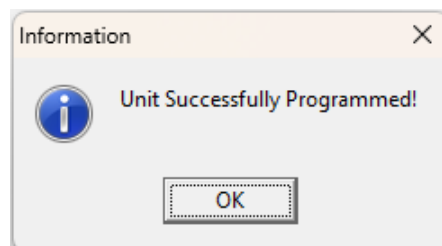



## 13. PRINT AND AUTOMATIC TRANSMISSION TOKENS

### 13.1 ASCII codes

Code	Char	Code	Ch	Code	Ch	Code	Ch	Code	Ch
000 (*)	NULL	026 (1A <sub>H</sub> )	SUB	052 (34 <sub>H</sub> )	'4'	078 (4E <sub>H</sub> )	'N'	104 (68 <sub>H</sub> )	'h'
001 (01 <sub>H</sub> )	SOH	027 (1B <sub>H</sub> )	ESC	053 (35 <sub>H</sub> )	'5'	079(4F <sub>H</sub> )	'O'	105 (69 <sub>H</sub> )	'i'
002 (02 <sub>H</sub> )	STX	028 (1C <sub>H</sub> )	FS	054 (36 <sub>H</sub> )	'6'	080 (50 <sub>H</sub> )	'P'	106 (6A <sub>H</sub> )	'j'
003 (03 <sub>H</sub> )	ETX	029 (1D <sub>H</sub> )	GS	055 (37 <sub>H</sub> )	'7'	081 (51 <sub>H</sub> )	'Q'	107 (6B <sub>H</sub> )	'k'
004 (04 <sub>H</sub> )	EOT	030 (1E <sub>H</sub> )	RS	056 (38 <sub>H</sub> )	'8'	082 (52 <sub>H</sub> )	'R'	108 (6C <sub>H</sub> )	'l'
005 (05 <sub>H</sub> )	ENQ	031 (1F <sub>H</sub> )	US	057 (39 <sub>H</sub> )	'9'	083 (53 <sub>H</sub> )	'S'	109 (6D <sub>H</sub> )	'm'
006 (06 <sub>H</sub> )	ACK	032 (20 <sub>H</sub> )	""	058 (3A <sub>H</sub> )	':'	084 (54 <sub>H</sub> )	'T'	110 (6E <sub>H</sub> )	'n'
007 (07 <sub>H</sub> )	BEL	033 (21 <sub>H</sub> )	'!	059 (3B <sub>H</sub> )	','	085 (55 <sub>H</sub> )	'U'	111 (6F <sub>H</sub> )	'o'
008 (08 <sub>H</sub> )	BS	034 (22 <sub>H</sub> )	"""	060 (3C <sub>H</sub> )	'<'	086 (56 <sub>H</sub> )	'V'	112 (70 <sub>H</sub> )	'p'
009 (09 <sub>H</sub> )	HT	035 (23 <sub>H</sub> )	'#'	061 (3D <sub>H</sub> )	'='	087 (57 <sub>H</sub> )	'W'	113 (71 <sub>H</sub> )	'q'
010 (0A <sub>H</sub> )	LF	036 (24 <sub>H</sub> )	'\$'	062 (3E <sub>H</sub> )	'>'	088 (58 <sub>H</sub> )	'X'	114 (72 <sub>H</sub> )	'r'
011 (0B <sub>H</sub> )	VT	037 (25 <sub>H</sub> )	'%'	063 (3F <sub>H</sub> )	'?'	089 (59 <sub>H</sub> )	'Y'	115 (73 <sub>H</sub> )	's'
012 (0C <sub>H</sub> )	FF	038 (26 <sub>H</sub> )	'&'	064 (40 <sub>H</sub> )	'@'	090 (5A <sub>H</sub> )	'Z'	116 (74 <sub>H</sub> )	't'
013 (0D <sub>H</sub> )	CR	039 (27 <sub>H</sub> )	""	065 (41 <sub>H</sub> )	'A'	091 (5B <sub>H</sub> )	'['	117 (75 <sub>H</sub> )	'u'
014 (0E <sub>H</sub> )	SO	040 (28 <sub>H</sub> )	'('	066 (42 <sub>H</sub> )	'B'	092 (5C <sub>H</sub> )	'\'	118 (76 <sub>H</sub> )	'v'
015 (0F <sub>H</sub> )	SI	041 (29 <sub>H</sub> )	)'	067 (43 <sub>H</sub> )	'C'	093 (5D <sub>H</sub> )	']'	119 (77 <sub>H</sub> )	'w'
016 (10 <sub>H</sub> )	DLE	042 (2A <sub>H</sub> )	'*'	068 (44 <sub>H</sub> )	'D'	094 (5E <sub>H</sub> )	'^'	120 (78 <sub>H</sub> )	'x'
017 (11 <sub>H</sub> )	DC1	043 (2B <sub>H</sub> )	'+'	069 (45 <sub>H</sub> )	'E'	095 (5F <sub>H</sub> )	'_'	121 (79 <sub>H</sub> )	'y'
018 (12 <sub>H</sub> )	DC2	044 (2C <sub>H</sub> )	','	070 (46 <sub>H</sub> )	'F'	096 (60 <sub>H</sub> )	''	122 (7A <sub>H</sub> )	'z'
019 (13 <sub>H</sub> )	DC3	045 (2D <sub>H</sub> )	'-'	071 (47 <sub>H</sub> )	'G'	097 (61 <sub>H</sub> )	'a'	123 (7B <sub>H</sub> )	'{'
020 (14 <sub>H</sub> )	DC4	046 (2E <sub>H</sub> )	':'	072 (48 <sub>H</sub> )	'H'	098 (62 <sub>H</sub> )	'b'	124 (7C <sub>H</sub> )	' '
021 (15 <sub>H</sub> )	NAK	047 (2F <sub>H</sub> )	/'	073 (49 <sub>H</sub> )	'I'	099 (63 <sub>H</sub> )	'c'	125 (7D <sub>H</sub> )	'}'
022 (16 <sub>H</sub> )	SYN	048 (30 <sub>H</sub> )	'O'	074 (4A <sub>H</sub> )	'J'	100 (64 <sub>H</sub> )	'd'	126 (7E <sub>H</sub> )	'~'
023 (17 <sub>H</sub> )	ETB	049 (31 <sub>H</sub> )	'1'	075 (4B <sub>H</sub> )	'K'	101 (65 <sub>H</sub> )	'e'	127 (7F <sub>H</sub> )	DEL
024 (18 <sub>H</sub> )	CAN	050 (32 <sub>H</sub> )	'2'	076 (4C <sub>H</sub> )	'L'	102 (66 <sub>H</sub> )	'f'		
025 (19 <sub>H</sub> )	EM	051 (33 <sub>H</sub> )	'3'	077 (4D <sub>H</sub> )	'M'	103 (67 <sub>H</sub> )	'g'		

(\*) Use ASCII 128 to implement a literal NULL character in a custom string. ASCII 0 is used to define the end of the string.

## 13.2 Use of Characters in the Extended ASCII table

To use characters in the extended ASCII table, 026 (1A<sub>H</sub>) should be used - it will allow the next character in a custom print string to be sent directly.

Example:

\1A\84 would be ä

## 13.3 Tokens

Tokens are special ASCII characters outside the normal printing range. These characters are used to specify where instrument data fields like 'Current Weight' are to be inserted into custom format strings.

### Non-paged generic tokens

Code		Token
191	(BF <sub>H</sub> )	Date
192	(C0 <sub>H</sub> )	Time
193	(C1 <sub>H</sub> )	New line (with lead spaces)
194	(C2 <sub>H</sub> )	Lead spaces
195	(C3 <sub>H</sub> )	Lead lines
196	(C4 <sub>H</sub> )	End lines
197	(C5 <sub>H</sub> )	Print ID
198	(C6 <sub>H</sub> )	Header
199	(C7 <sub>H</sub> )	Footer
211	(D3 <sub>H</sub> )	Time (12 Hour format)
213	(D5 <sub>H</sub> )	User clearable print ID
214	(D6 <sub>H</sub> )	Clear user clearable print ID

### Page tokens

As there is too much data to represent as individual tokens the tokens are divided up into pages. A page token is used to define the page for all subsequent tokens.

Code		Token
190	(BE <sub>H</sub> )	Page 0: Current Weight
189	(BD <sub>H</sub> )	Page 1: Held Weight
188	(BC <sub>H</sub> )	Page 2: Held or Current
187	(BB <sub>H</sub> )	Page 3: Traceable Weight

186	(BA <sub>H</sub> )	Page 4:Totals
185	(B9 <sub>H</sub> )	Page 5: Status
182	(B6 <sub>H</sub> )	Page 8: Misc
180	(B4 <sub>H</sub> )	Page 10: Strings

### Page 0 (BE<sub>H</sub>), 1 (BD<sub>H</sub>), 2 (BC<sub>H</sub>), 3 (BB<sub>H</sub>) tokens: Weight Information

These pages hold weight information. The same codes are used for each page.

Code		Token
215	(D7 <sub>H</sub> )	Displayed weight
216	(D8 <sub>H</sub> )	Gross weight
217	(D9 <sub>H</sub> )	Net weight
218	(DA <sub>H</sub> )	Combined tare weight
219	(DB <sub>H</sub> )	Tare label "T" or "PT"
220	(DC <sub>H</sub> )	PT weight
221	(DD <sub>H</sub> )	User tare
222	(DE <sub>H</sub> )	Non- displayed weight (gross or net)
223	(DF <sub>H</sub> )	NetPT weight
224	(EO <sub>H</sub> )	Piece count

### Page 0 (BE<sub>H</sub>) only tokens

These tokens hold current weight information.

Code		Token
226	(E2 <sub>H</sub> )	mV/V
227	(E3 <sub>H</sub> )	Peak gross weight in primary units
228	(E4 <sub>H</sub> )	Date of peak held weight
229	(E5 <sub>H</sub> )	Time of peak held weight
230	(E6 <sub>H</sub> )	Auto out weight (set in SER.AUT -> SOURCE)

### Page 3 (BB<sub>H</sub>) only tokens

These tokens hold traceable weight information.

Code		Token
226	(E2 <sub>H</sub> )	Traceable weight date

227	(E3 <sub>H</sub> )	Traceable weight time
-----	--------------------	-----------------------

**Page 4 (BA<sub>H</sub>) tokens: Totals Information:**

These pages hold totals information where:

Code		Token
215	(D7 <sub>H</sub> )	Total weight (gross + net)
216	(D8 <sub>H</sub> )	Total gross weight
217	(D9 <sub>H</sub> )	Total net weight
218	(DA <sub>H</sub> )	Total piece count
219	(DB <sub>H</sub> )	Total gross piece count
220	(DC <sub>H</sub> )	Total net piece count
221	(DD <sub>H</sub> )	Number of adds to totals
222	(DE <sub>H</sub> )	Number of adds to gross totals
223	(DF <sub>H</sub> )	Number of adds to net totals
224	(E0 <sub>H</sub> )	Number of adds to piece count totals
225	(E1 <sub>H</sub> )	Number of adds to gross piece count totals
226	(E2 <sub>H</sub> )	Number of adds to net piece count totals

**Page 5 (B9<sub>H</sub>) tokens: Status Information:**

These pages hold status information where:

Code	Status	Options	Token
215	(D7 <sub>H</sub> )	0	G, N, E, O, U, M, ''
216	(D8 <sub>H</sub> )	1	G, N, E, O, U, ''
217	(D9 <sub>H</sub> )	2	M, ''
218	(DA <sub>H</sub> )	3	Z, ''
219	(DB <sub>H</sub> )	4	-, 1, 2, 3
220	(DC <sub>H</sub> )	5	M, C, ''
221	(DD <sub>H</sub> )	6	_G_, _N_, _
223	(DF <sub>H</sub> )	8	I, O, U
224	(E0 <sub>H</sub> )	9	M, S
225	(E1 <sub>H</sub> )	10	ST, US, OL

226	(E2 <sub>H</sub> )	11	G, N	Gross, Net
227	(E3 <sub>H</sub> )	12	K, L, T, G, ''	Weight units kg, lb, t/T, g
229	(E5 <sub>H</sub> )	14	O, I, M, ''	Over/underload, error, Motion
230	(E6 <sub>H</sub> )	15	GS, NT	Gross, Net
234	(EA <sub>H</sub> )	19	R, G, B, O	Setpoint 1 active, setpoint 2 active, setpoints 1 & 2 active, setpoints 1 & 2 inactive.
235	(EB <sub>H</sub> )	20		Fairbanks "Remote" status
236	(EC <sub>H</sub> )	21	O, M, ''	Over/underload, Motion
237	(ED <sub>H</sub> )	22	GR, NT, gr, nt	Gross stable, net stable, gross motion, net motion
238	(EE <sub>H</sub> )	23		Fairbanks status A
239	(EF <sub>H</sub> )	24		Fairbanks/Toledo status B
240	(FO <sub>H</sub> )	25		Fairbanks/Toledo status C
241	(F1 <sub>H</sub> )	26		3 char units of last weight sent
242	(F2 <sub>H</sub> )	27		Toledo status A
254	(FE <sub>H</sub> )			IO status
255	(FF <sub>H</sub> )			Setpoint status

### Page 8 (B6<sub>H</sub>) tokens: Miscellaneous weight data

These tokens hold weight/alternate weight information depending on which is being displayed.

	Code	Token
215	(D7 <sub>H</sub> )	Serial number
218	(DA <sub>H</sub> )	Primary units
219	(DB <sub>H</sub> )	Secondary units
220	(DC <sub>H</sub> )	Tertiary units
221	(DD <sub>H</sub> )	Display string
222	(DE <sub>H</sub> )	Display units
223	(DF <sub>H</sub> )	Flip string direction
225	(E1 <sub>H</sub> )	Epson release command
226	(E2 <sub>H</sub> )	Horizontal line of ' _ '
227	(E3 <sub>H</sub> )	Time delimiter is ' . '
228	(E4 <sub>H</sub> )	Date delimiter is ' - '

229	(E5 <sub>H</sub> )	Date delimiter is ‘.
230	(E6 <sub>H</sub> )	Calibration count OIML
231	(E7 <sub>H</sub> )	Calibration count NTEP
232	(E8 <sub>H</sub> )	Configuration count NTEP

### Page 10 (B4<sub>H</sub>) only tokens

These pages hold status information where:

Code		Token
215	(D7 <sub>H</sub> )	Items
216	(D8 <sub>H</sub> )	Totals
217	(D9 <sub>H</sub> )	Empty string
218	(DA <sub>H</sub> )	Seq
219	(DB <sub>H</sub> )	Net
220	(DC <sub>H</sub> )	Gross
221	(DD <sub>H</sub> )	Tare
222	(DE <sub>H</sub> )	PT

### Format tokens

Format tokens define the behavior of all subsequent tokens in a string.

Code		Format Tokens
149	(95 <sub>H</sub> )	Decrement weight length to minimum of 3 characters
150	(96 <sub>H</sub> )	Increment weight length to maximum of 10 characters
151	(97 <sub>H</sub> )	Weights in primary units
152	(98 <sub>H</sub> )	Weights in secondary units
153	(99 <sub>H</sub> )	Weights in tertiary units
154	(9A <sub>H</sub> )	Weights in displayed units
155	(9B <sub>H</sub> )	Don't send sign characters
156	(9C <sub>H</sub> )	Positive symbol ‘.’, negative ‘-’
157	(9D <sub>H</sub> )	Positive symbol ‘0’, negative ‘-’
158	(9E <sub>H</sub> )	Positive symbol ‘+’, negative ‘-’
159	(9F <sub>H</sub> )	Don't send decimal point
160	(A0 <sub>H</sub> )	Decimal point is ‘.’

161	(A1 <sub>H</sub> )	Decimal point is ‘.’
162	(A2 <sub>H</sub> )	Don't send leading characters
163	(A3 <sub>H</sub> )	Leading character ‘ ’
164	(A4 <sub>H</sub> )	Leading character ‘0’
165	(A5 <sub>H</sub> )	Send weight even on error
166	(A6 <sub>H</sub> )	Send weight as dashes “-----” on error
167	(A7 <sub>H</sub> )	Send weight as spaces “ ” on error
168	(A8 <sub>H</sub> )	Status characters are uppercase
169	(A9 <sub>H</sub> )	Status characters are lowercase
170	(AA <sub>H</sub> )	Toggle sending units after weight
171	(AB <sub>H</sub> )	Always send decimal point even if at the end of the weight
172	(AC <sub>H</sub> )	Turn line tracking off
173	(AD <sub>H</sub> )	Toggle space between weight and units
175	(AF <sub>H</sub> )	Don't send weight, just sets last weight variable for status token
176	(B0 <sub>H</sub> )	Set weight length to 8 characters
177	(B1 <sub>H</sub> )	Place sign character adjacent to the weight
178	(B2 <sub>H</sub> )	Add D840 traffic light status to sign character

Printouts have default format tokens of line and page tracking are enabled and:

Weight	Time
<ul style="list-style-type: none"> <li>• 8-character weight string</li> <li>• Decimal point symbol is ‘.’</li> <li>• Leading characters are spaces</li> <li>• Weight is sent on error</li> <li>• Positive sign is space, negative sign is ‘-’</li> <li>• Weights are displayed with units</li> <li>• Status characters are uppercase</li> </ul>	<ul style="list-style-type: none"> <li>• Date separator is ‘/’</li> <li>• Time separator is ‘:’</li> <li>• Date format is the format configured in the setup menu</li> <li>• Time is 24 hour</li> </ul>

The Format token must be used before the token that requires the formatting. For example, where the current weight is 10kg and a formatted with no units is needed:

\BE\AA\D7 would be 10

Whereas if the AA is used after the D7 it has no effect.

\BE\D7\AA would be 10kg

# 14. APPENDIX - DIMENSIONS

C320 Panel Mount.

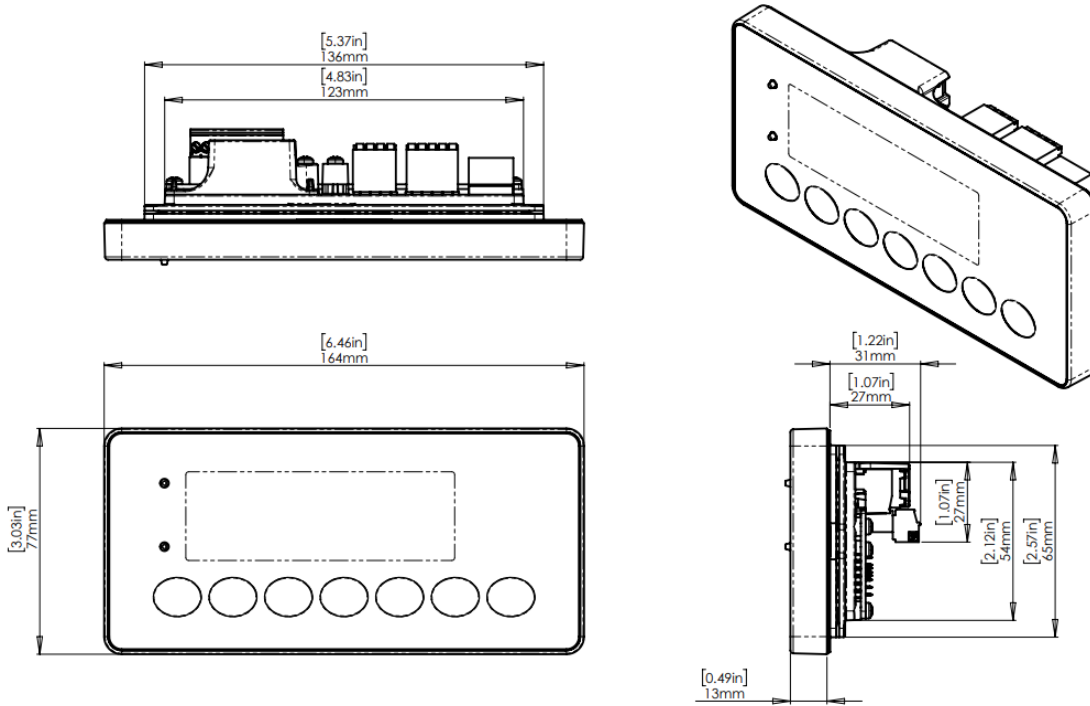

C320 with M6001 black desk mount housing on a desk.

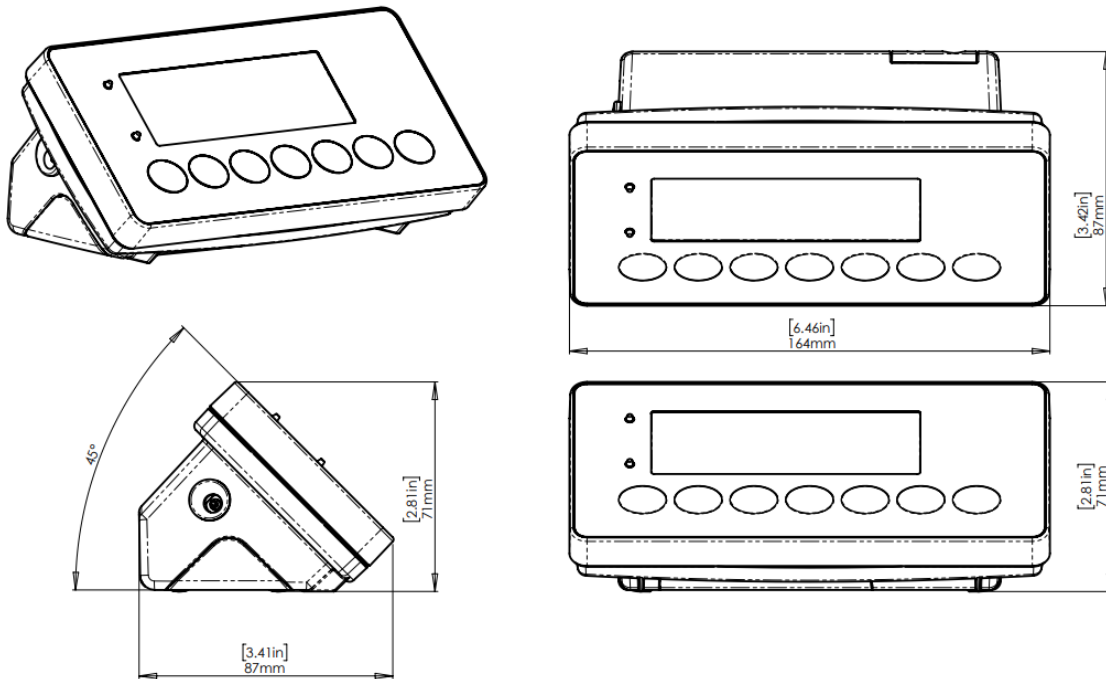



C320 with M6001 black desk mount housing mounted on a desk.

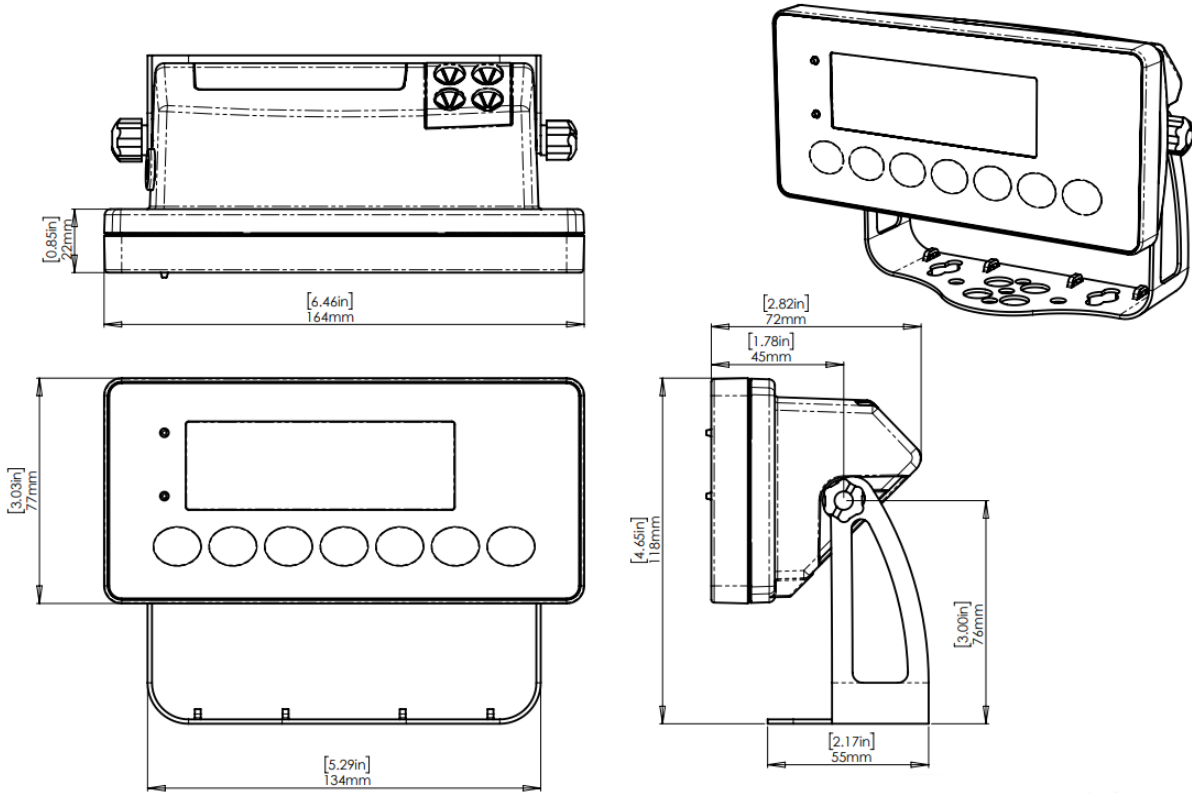

C320 with M6001 black desk mount housing mounted on a wall.

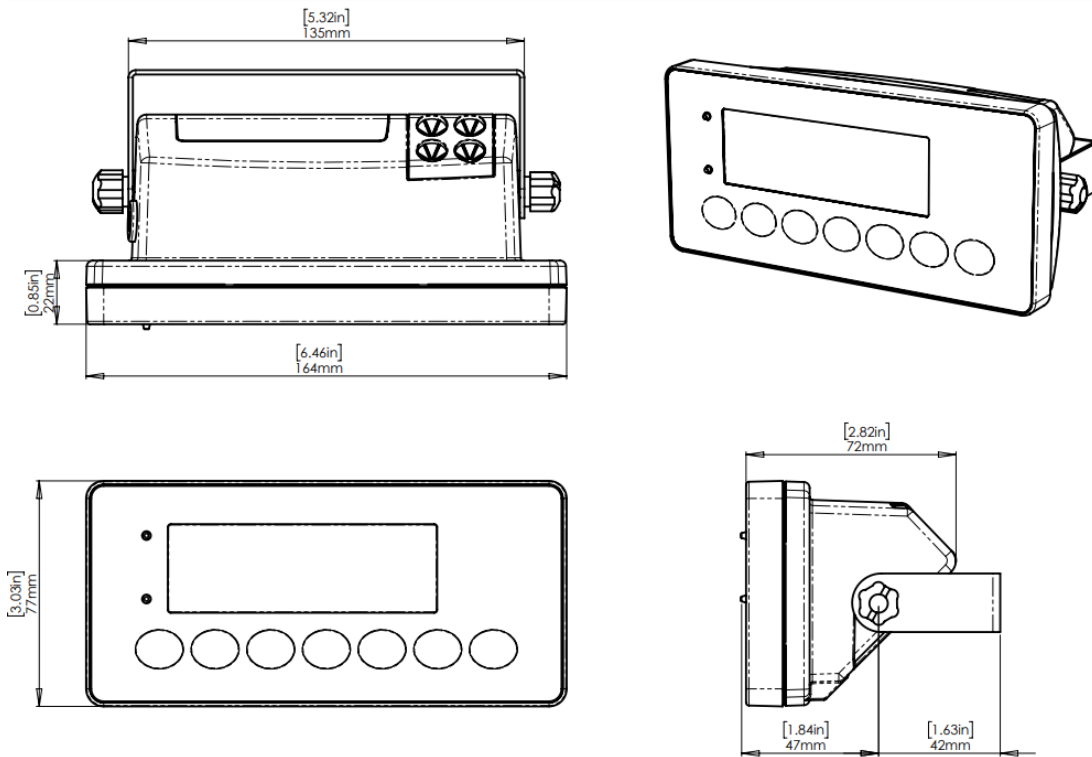

C320 with M6003 black desk mount housing mounted on a desk.

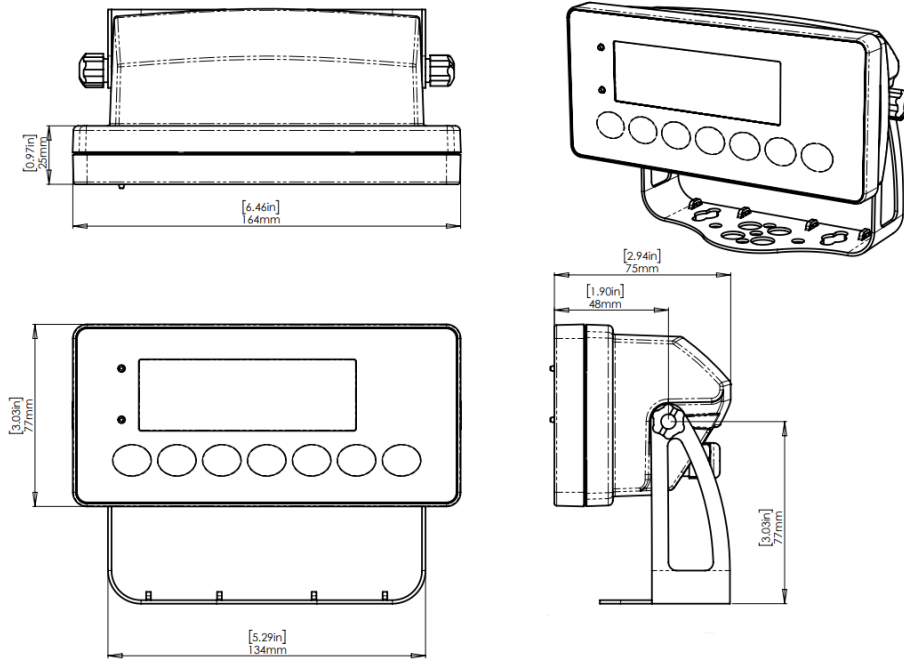

C320 with M6003 black desk mount housing mounted on a wall.

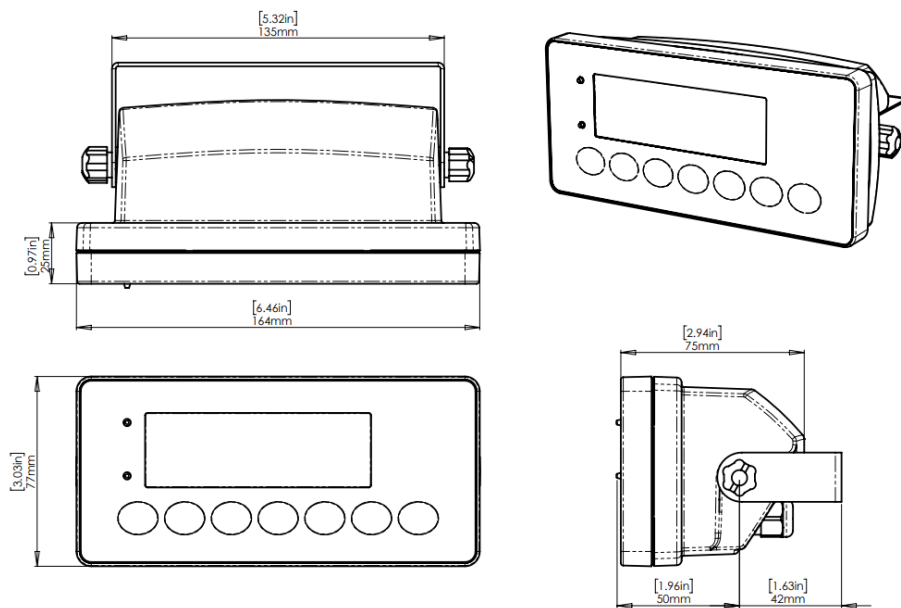

C350 Desk/Wall Mount.

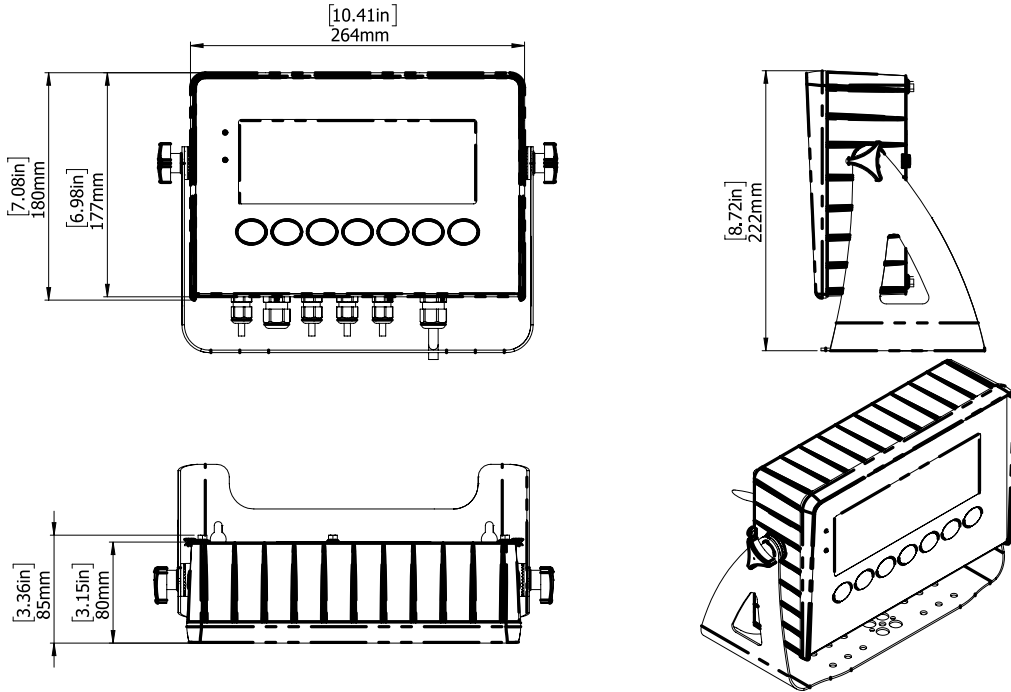

C357 Desk/Wall Mount.

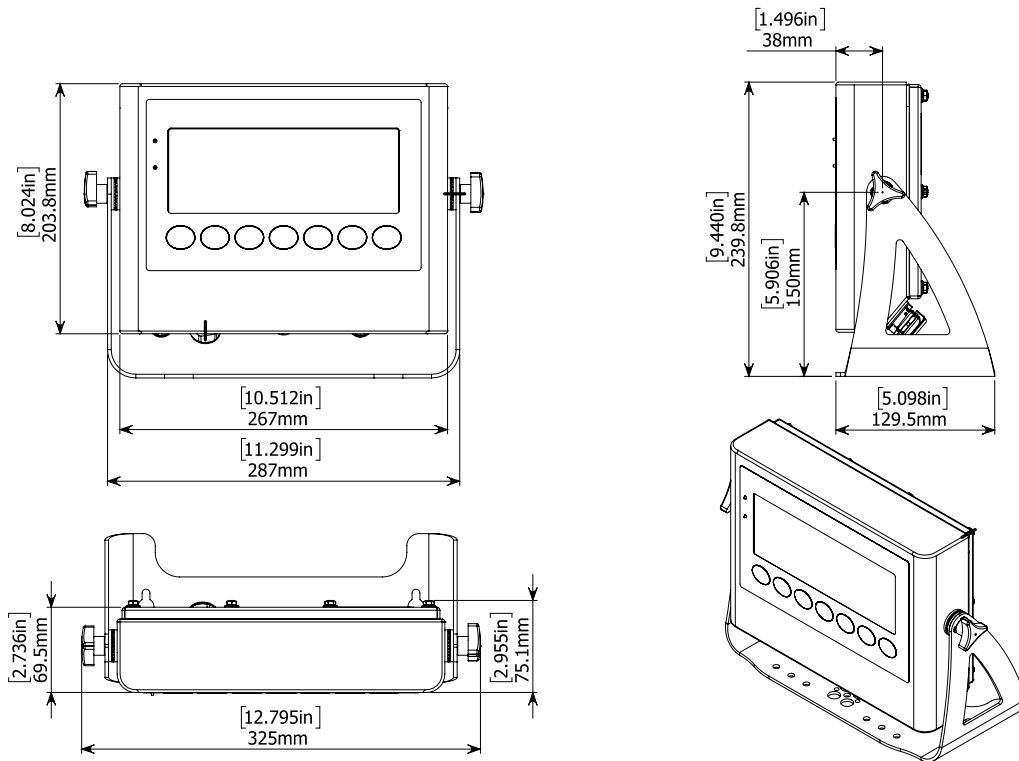

## 15. APPENDIX - ERROR MESSAGES

### Overview

A number of error messages may be displayed to warn of operation outside of the acceptable limits. These messages may appear on either the primary or the secondary display.

Short messages (XXXXXX) will appear as a single message. Longer messages (XXXXXX) (YYYYYY) will appear on the display in two parts, first the (XXXXXX) part, then the (YYYYYY) part.

### 15.1 Weighing Errors

These messages show status messages or errors that may occur during normal weighing operation.

Error	Description	Resolution
(U.LOAD)	The weight is below the minimum allowable weight reading.	Increase the weight or decrease the minimum allowable weight reading.
(O.LOAD)	The weight is above the maximum allowable weight reading. Warning - overloading may damage mechanical scale elements.	Check the condition of load cell connections. Check for damaged load cell.
(ERROR) (RANGE)	The weight reading is beyond the limit set for Zero operation. The operation of the <ZERO> key is limited in the setup during installation. The indicator cannot be Zeroed at this weight.	Increase the Zero Range (Z.RANGE) or use the <TARE> key instead.
(ERROR) (MOTION)	Scale motion has prevented a <ZERO> or <TARE> operation from occurring on command.	Try the operation again once the scale is stable.
(ERROR) (ADC)	An error with the ADC has prevented a <ZERO> or <TARE> operation from occurring on command.	Ensure loadcell cabling is correct.
(TILT.HI)	The X angle has exceeded MAX.X setting, the Y angle has exceeded the MAX.Y setting, the combined XY angle has exceeded the MAX.XY setting or has exceeded the maximum tilt range of the sensor	Operate the system within these limits.

### 15.2 Setup Errors

These messages show status messages or errors that may occur during the instrument setup.

Error	Description	Resolution
(ENTRY) (DENIED)	When accessing setup, more than three attempts have been made	Turn the instrument off. When the instrument is turned back on, enter the

Error	Description	Resolution
	with the incorrect passcode.	correct passcode to access setup.
(WR DENIED) (RD DENIED)	The instrument may be in Safe Setup and an item that needs Full Setup has been selected for editing.	Access Full Setup to access this item.

### 15.3 Diagnostic Errors

The instrument continually monitors the condition of the internal circuits. Any faults or out-of-tolerance conditions are shown on the display as an E type error message. In the table below the following terms are used:

- Check: This item can be checked on site by service personnel.
- Return for Service: The instrument must be returned for factory service.

Error	Description	Resolution
(E0001)	The power supply voltage is too low.	Check supply
(E0002)	The power supply voltage is too high.	Check scale / cables
(E0004)	Positive sense voltage out of range.	Check scale connections and SCALE:BUILD:CABLE setting.
(E0008)	Negative sense voltage out of range.	Check scale connections and SCALE:BUILD:CABLE setting.
(E0010)	Temperature is outside of allowable limits	Check location
(E0020)	Module Error	Replace Module
(E0040)	Data not received from Tilt Sensor	Check Tilt Sensor
(E0200)	The calibration information has been lost.	Re-calibrate
(E0400)	The factory information has been lost.	Return for Service
(E0800)	Application settings have been set to defaults.	Check and re-enter application settings
(E2000)	ADC Out of Range Error. This may be caused from a broken load cell cable.	Check BUILD:CABLE setting. Check load cell cable, wiring, etc.
(E4000)	The runtime information has been lost.	Check Zero and tare settings.

The E type error messages are additive. For example if instrument is running off batteries and the temperature drops, the battery voltage may be too low. The resulting error messages will be E 0011 (0001 + 0010). The numbers add in hexadecimal as follows:

1 - 2 - 3 - 4 - 5 - 6 - 7 - 8 - 9 - A - B - C - D - E - F  
(For example, 2 + 4 = 6, or 4 + 8 = C)

---

## 15.4 Calibration Errors

<b>Error</b>	<b>Description</b>	<b>Resolution</b>
(FAILED) (BAND)	An attempt has been made to calibrate with a weight or signal which is not in the valid range.	Check weights and retry.
(FAILED) (ERROR)	An attempt has been made to calibrate while the scale signal is not valid.	Check loadcell connection and the 4-wire/6-wire setting.
(FAILED) (TIMEOUT)	For an unknown reason, the calibration was unable to complete.	Retry.
(FAILED) (RES)	An attempt has been made to calibrate the scale to a resolution which is too high for the instrument.	Check weights and retry.
(FAILED) (TOO CLOSE)	An attempt has been made to add a linearisation point too close to zero, span or another linearisation point.	Check weights and retry.